

DESIGN OF STEEL STRUCTURES

Dr. G.C.Behera

LESSON PLAN

FACULTY NAME	:	G.C. BEHERA	EMP. CODE	:	
SUBJECT	:	DESIGN OF STEEL STRUCTURES	SUB. CODE	:	RCI6001
YEAR	:	3rd	SEMESTER	:	VI
PROGRAMME & BRANCH	:	B. Tech. & Civil	SECTION	:	

COURSE OBJECTIVE:

The objectives of this course are:

- 1. To learn the behaviour and design of structural steel components, for example, members and connections in two - dimensional (2D) truss and frame structures.**
- 2. To gain an educational and comprehensive experience in the design of simple steel structures..**
- 3. Familiarity with professional and contemporary issues.**

COURSE OUTCOME:

Students who successfully complete this course will be able to:

- 1. Infer the design philosophies of structural steel using limit state method . (L2)**
- 2. Analyze the failure modes of various types of connections.(L4)**
- 3. Design of various elements of steel structures as per Indian Standards.(L6)**
- 4. Apply relevant codal provisions to ensure the safety and serviceability of structural elements for the recommendation. (L3, L6)**

6 th Semester	RCI6C001	Design of Steel Structures	L-T-P 3-0-0	3 Credits
-----------------------------	----------	----------------------------	----------------	--------------

Module I**10 HOURS**

Introduction, advantages/disadvantages of steel, structural steel, rolled steel section, various types of loads, design philosophy.

Limit state design method, limit states of strength and serviceability, probabilistic basis for design
Riveted, bolted and pinned connections.

Welded connections-assumptions, types, design of fillet welds, intermittent fillet weld, plug and slot weld, failure of welded joints, welded joints vs bolted and riveted joints

Module II**6 HOURS**

Tension members, types, net cross-sectional area, types of failure, slenderness ratio, design of tension members, gusset plate.

Module III**6HOURS**

Compression members, effective length, slenderness ratio, types of cross-section, classification of cross section,

Design of axially loaded compression members, lacing, battening, design of column bases, and foundation bolts.

Module IV**8 HOURS**

Design of beams, types of c/s, lateral stability of beams, lateral torsional buckling, bending and shear strength, web buckling and web crippling, deflection, design procedure.

Module V**6HOURS**

Plate girders- various elements and design of components Eccentric and moment connections, roof trusses

Books:

1. Design of Steel Structures- Limit State Method by N. Subramanian, Oxford University Press
2. Limit State Design of Steel structures by S.K. Duggal, Mc-Graw Hill
3. Design of steel structures by S.S.Bhavikatti, I.K. International Publishing house.
4. Design of Steel Structures by K. S. Sairam, Pearson
5. Steel Design by William T. Segui, Cengage Learning
6. Fundamentals of Structural Steel Design by M.L.Gambhir, Mc Graw Hill
7. Steel Structures-Design and Practice by N. Subramanian, Oxford University Press

Books:**Digital Learning Resources:**

Course Name	Design of Steel Structure
Course Link	https://nptel.ac.in/courses/105/105/105105162/
Course Instructor	PROF. DAMODAR MAITY

STEEL VS CONCRETE

- Concrete the most versatile material for construction?
- Why Steel?
 - Skyscrapers, these are mostly built with the steel. Steel has lot of advantages.
 - Steel sections are massively used particularly in bridge structure and in transmission tower,
 - Refinery well structure. Sometimes some water tanks, some high rise buildings, many industrial buildings, sheds are made of steels. Steel is much stronger than the conventional concrete.
 - Construction material like concrete, its strength to weight ratio is very high i.e. its weight is very less and strength is very high. It is much ductile compared to concrete and, because of its advantages designer prefers steel structure, though it is costly.

DESIGN PROCEDURE

WHAT IS DESIGN WHY DESIGN

- The components or the entire structure should withstand the load throughout its life span satisfying serviceability criteria.
- Design properly a structure without affecting safety with cost effective way.
- This requires knowledge of the design procedure properly.

STEEL

- Strength of steel is of approximately ten times that of concrete.
- Steel has large strength to weight ratio, steel structures.
- Steel to be more economical than concrete structures for tall buildings and large span buildings and bridges.
- Steel structures can be constructed very fast and this enables the structure to be used early thereby leading to overall economy.
- Steel structures are ductile and robust and can withstand severe loadings such as earthquakes.
- Steel structures can be easily repaired and retrofitted to carry higher loads.
- Steel is also a very eco-friendly material and steel structures can be easily dismantled and sold as scrap.
- Thus the lifecycle cost of steel structures, which includes the cost of construction, maintenance, repair and dismantling, can be less than that for concrete structures.
- As produced in factory under better quality control, steel structures have higher reliability and safety.

demerits

- To get the most benefit out of steel,
- steel structures should be protected to resist corrosion.
- Protected from fire.
- Good quality control is essential to ensure proper fitting of the various structural elements.
- The effects of temperature should be considered in design.
- To prevent development of cracks under fatigue and earthquake loads the connections and in particular the welds should be designed and detailed properly. Special steels and protective measures

Chemical composition of steel:

Steel is an alloy which mainly contains iron and carbon. Apart from the carbon a small percentage of manganese, silicon, phosphorus, nickel and copper are also added to modify the specific properties of the steel.

Chemical composition of structural steel (IS 2062-1992 & IS 8500)

Grade	C	Mn	S	P	Si	Carbon Equivalent
Fe410WA	0.23	1.50	0.050	0.050	0.40	0.42
Fe410WB	0.22	1.50	0.045	0.045	0.40	0.41
Fe410WC	0.20	1.50	0.040	0.040	0.40	0.39
Fe 440	0.20	1.30	0.05(0.04)	0.05(0.04)	0.45	0.40
Fe 490	0.20	1.50	0.05(0.04)	0.05(0.04)	0.45	0.42
Fe 590	0.22	1.80	0.045(0.04)	0.045(0.04)	0.45	0.48

Notes:

- $\text{Carbon Equivalent} = \frac{(C+Mn)}{6} + \frac{(Cr+Mo+V)}{5} + \frac{(Ni+Cu)}{15}$
- The terms in the bracket denotes the maximum limit for the flat products.

Types of structural steel:

Different structural steel can be produced based on the necessity by changing slightly the chemical composition and manufacturing process.

- Carbon steel:** In this type of structural steel carbon and manganese are used as extra elements.
- High Strength Carbon Steel:** By increasing the carbon content this type of steel can be manufactured which basically produces steel with comparatively higher strength but less ductility.
- Stainless Steel:** In this type of steel mainly foreign material like nickel and chromium are used along with small percentage of carbon.

Element	Concentration (%)		
	Mild steel	TMT steel	Prestressing steel
Cu	0.27	0.16	0.02
Co	-	0.02	0.01
Al	-	0.03	0.04
Ni	0.09	0.15	0.02
Mo	0.02	0.06	-
Cr	0.08	0.24	0.27
S	0.05	0.01	-
P	0.06	0.08	0.06
Mn	0.64	0.63	0.83
Si	0.26	0.24	0.29
C	0.19	0.2	0.84
Fe	remaining	remaining	remaining

Grades of rebars available in India - as per IS 1786:2016



- Fe 250
- Fe 415, Fe 415D, Fe 415S
- Fe 500, Fe 500D, Fe 500S
- Fe 550, Fe 550D
- Fe 600
- Fe 700

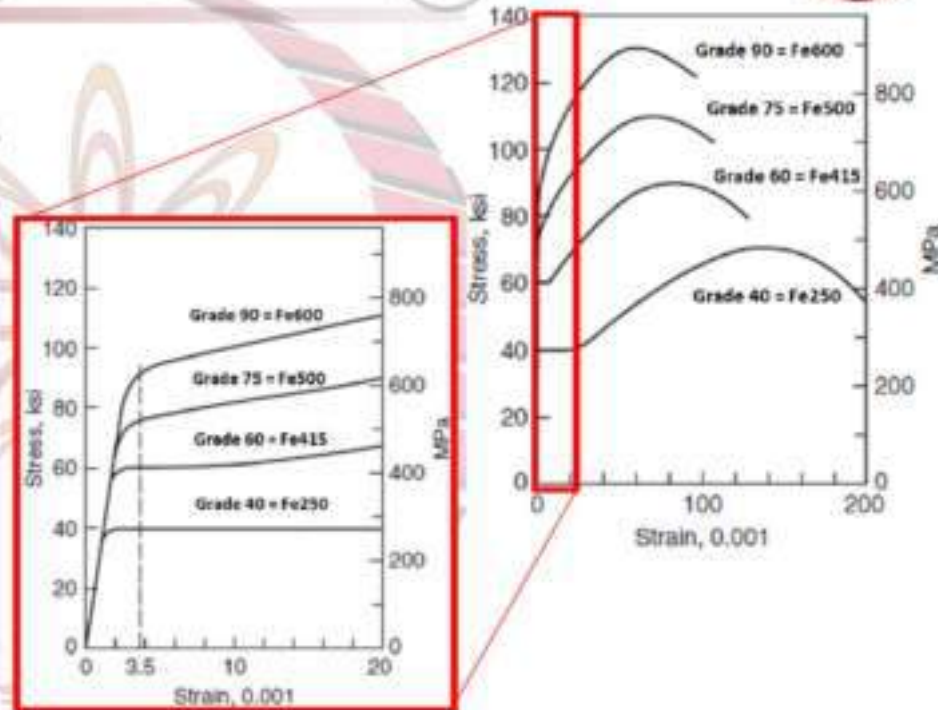
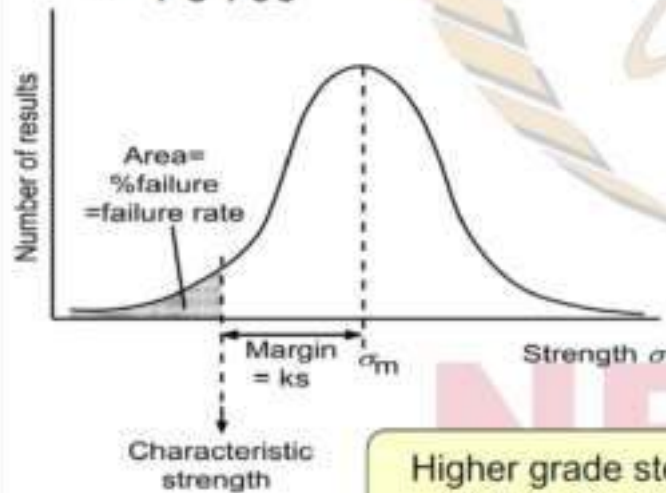

Higher grade steel must be used only if approved by structural engineers.
Adhoc changes at site to reduce congestion should not be practiced.

Influence of different chemical ingredients on properties of rebars



Chemicals	Effect on rebars
	Controlling property when at suitable concentration
Carbon (C)	Hardness, strength, weldability and brittleness < 0.1% carbon → reduced strength > 0.3% carbon → unweldable and brittle
Manganese (Mn)	Yield strength
Sulphur (S)	Brittleness
Phosphorous (P)	Strength and brittleness
Copper (Cu)	Strength and corrosion resistance
Chromium (Cr)	Weldability and corrosion resistance
Carbon equivalent (CE or C_{eq})	Hardness, tensile strength and weldability

Basu et al. 2004

Types of Reinforcing Bars/strands



-  1. Plain and ribbed (hot rolled) mild steel bars
-  2. Cold twisted deformed (CTD) steel bars
-  3. Thermo-mechanically treated (TMT) or Quenched and self-tempered (QST) steel bars
-  4. Corrosion-resistant steel (CRS) bars
-  5. Stainless steel bars
-  6. Prestressing steel strands
-  7. Galvanized steel bars
-  8. Fusion-bonded-epoxy coated (FBEC) steel bars
-  9. Cement-polymer-composite coated (CPCC) steel bars
-  10. Fiber reinforced polymer (FRP) bars

1. Plain and ribbed (hot-rolled) mild steel bars



- Plain bars
 - First type of hot-rolled bars (after the flat/strip reinforcement)
 - More resistant to corrosion than the cold-rolled steels
 - Not very much used in construction – due to the demand for higher strength
- Ribbed bars
 - Enhanced bond strength



2. Cold-Twisted Deformed (CTD) bars



- Ribbed steel bars, twisted to increase the yield strength
 - Cold-working or Work-hardening
 - Cold: at a temperature below the recrystallization temperature (usually between 400 and 700 °C)
 - Residual stresses
- Resistance to corrosion decreases due to the residual stresses

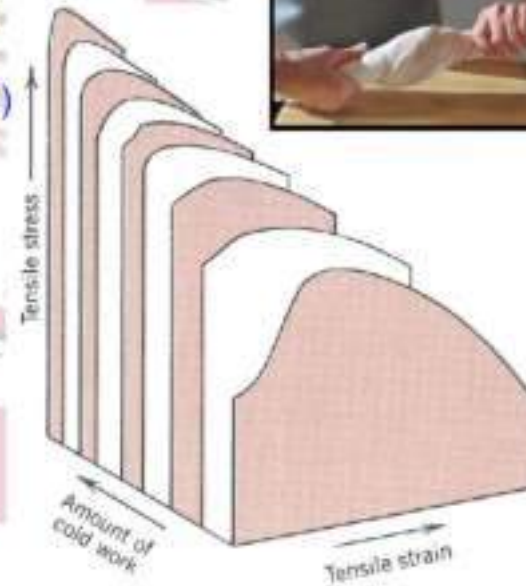

NPTI

2. Cold working process can lead to...



- Anisotropy in polycrystalline metals due to the deformation of the grains.

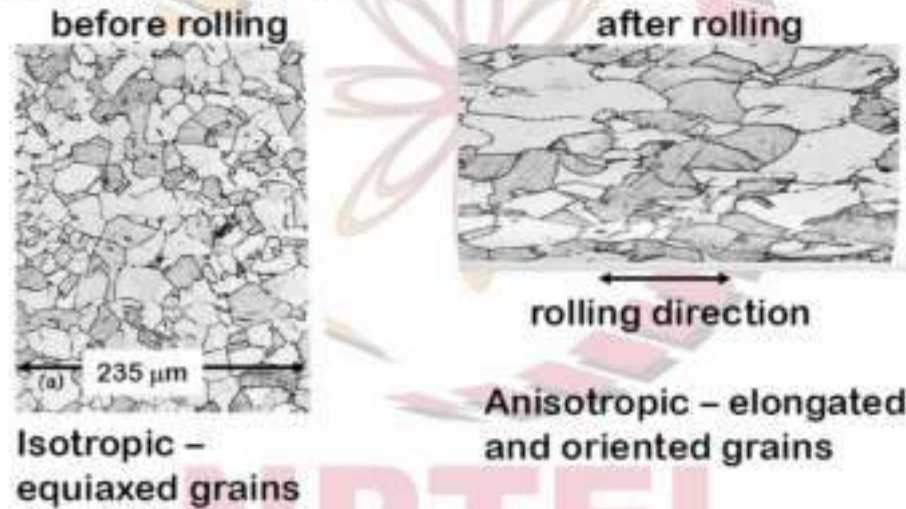

CTD bars are no longer used due to poor corrosion resistance

3. Thermomechanically Treated (TMT) or Quenched and Self-Tempered (QST) Bars



Process

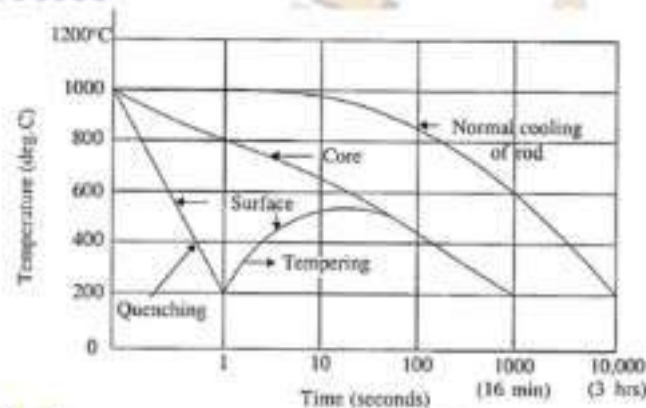

- After hot rolling to the desired size and shape, the low carbon steel bars are quenched with water and then cooled.
- Quenching converts the surface layer to (hard) martensite while the core remains as austenite.
- As the bar cools, heat flows from the core to the surface layer turning it to tempered martensite. The core transforms to ductile ferrite-pearlite.

Effect

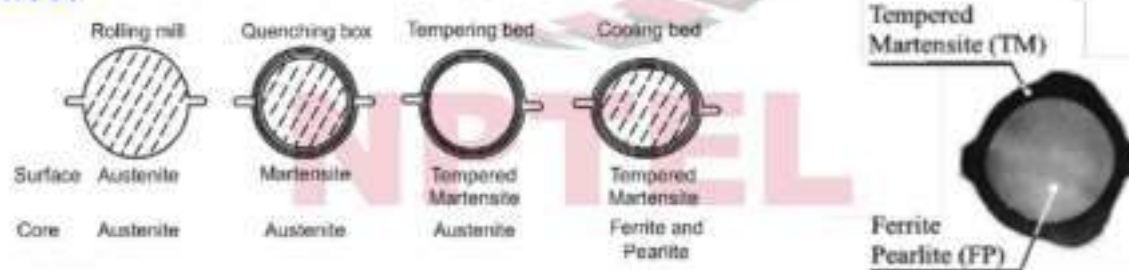

3. Thermomechanically Treated (TMT) or Quenched and Self-Tempered (QST) Bars



- Advantages
 - Low cost, high strength
 - High ductility (good for earthquake regions)
 - Elongation around 18-30%
 - Excellent weldability
 - No cold-working (better corrosion resistance)
- Identification/selection of TMT/QST bars
 - Select only if the hardened periphery and softer core are uniform and concentric in nature
 - Ideal if 20 to 30% of bar cross-sectional area is hardened periphery
 - Not ideal if >50% of bar cross-sectional area is hardened periphery (ductility reduces)
 - "TM-Ring" test

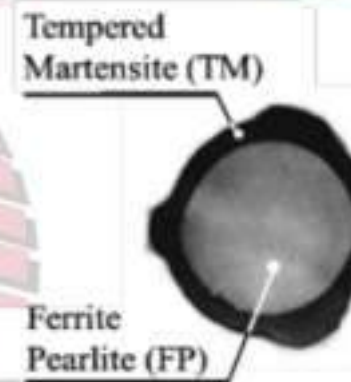

NPTTEL

PROPERTIES OF STRUCTURAL STEEL

- The properties of structural steel, as per clause 2.2.4 of IS 800:2007, for use in design, may be taken
- as given in clauses 2.2.4.1 and 2.2.4.2 of the code.

Physical properties

Physical properties of structural steel, as detailed by cl.2.2.4.1 of IS 800:2007, irrespective of its grade may be taken as:

- a) Unit mass of steel, $\rho = 7850 \text{ kg/m}^3$
- b) Modulus of elasticity, $E = 2.0 \times 10^5 \text{ N/mm}^2$ (MPa)
- c) Poisson ratio, $\nu = 0.3$
- d) Modulus of rigidity, $G = 0.769 \times 10^5 \text{ N/mm}^2$ (MPa)
- e) Coefficient of thermal expansion $\alpha = 12 \times 10^{-6} / ^\circ\text{C}$

Mechanical properties

The principal mechanical properties of the structural steel important in design, as detailed by the code IS 800:2007 in cl. 2.2.4.2, are the yield stress, f_y ; the tensile or ultimate stress, f_u ; the maximum percent elongation on a standard gauge length.

IS Code	Grade	Yield stress (Mpa) min (for d or t)			Ultimate tensile stress (MPa) min	Elongation Percent min
		<20	20 - 40	>40		
IS 2062	E 165 (Fe 290)	165	165	165	290	23
	E250(Fe410W)A	250	240	230	410	23
	E250(Fe 410 W)B	250	240	230	410	23
	E250(Fe 410 W)C	250	240	230	410	23
	E 300 (Fe 440)	300	290	280	440	22
	E 350 (Fe 490)	350	330	320	490	22
	E 410 (Fe 540)	410	390	380	540	20
	E 450 (Fe 570) D	450	430	420	570	20
	E 450 (Fe 590) E	450	430	420	590	20

- tensile force and it undergoes large inelastic. Inelastic deformation means permanent deformation without loss of strength under the application. So if we see the stress-strain diagram
- of the material if this is strain and this is stress then this portion is basically the ductility portion
- where stress is not developing as such, but the strain is going to be increase. If we release the
- load, it will be coming to its earlier position, of course not in same path, because it is inelastic,
- but it will come to its earlier position with deformation. If the material is ductile that means it
- will be much more seismic resistance. Therefore, we prefer ductile material so that deformations
- are allowed without failure.
- Then another property we also come across which is called hardness. Hardness is one of the
- mechanical properties of steel by virtue of which, it offers resistance to the indentation and
- scratching. So hardness can be measured by different test (the) like rock well test, rock well
- hardness test. Another test we make which is called Vickers hardness test and then another test

- through which the hardness is measured is called Brinell hardness test. So through this one can
- test the hardness of the material and another property also we come across is called toughness.
- Now toughness is the ability to absorb energy up to fracture. This toughness is measured by the
- area under the stress-strain curve. So stress-strain curve of this material and stress-strain curve of
- this material, the area we can find out and we can measure the toughness. It is a one type of
- mechanical property of steel. So basically it offers resistance to fracture under the action of the
- impact load. So this is one property another is fatigue. Fatigue means the repeated loading. It
- means damage is caused due to repeated loading, repeated fluctuation of stresses and which leads
- to progress of cracking of the structural element and due to cyclic loading damage and failure of
- the material may happen which is called fatigue.
- In addition, another is resistance against corrosion. In presence of moisture, corrosion of steel
- happens. So to avoid that what we can do? We can go for painting or metallic coating. So either
- of these two can be made to take care the corrosion. So this is one property which we have to
- keep in mind and then another property is residual stress.

CODES

Codes

- Code of practice for general construction in steel → IS: 800 - 2007
- Handbook for structural engineers
→ SP: 6(1) – 1964 (Reaffirmed 2003)
- IS 808 : 1989 (Reaffirmed 2004)
- Steel Tables of any standard publication.
- Code of practice for design loads (other than earthquake) for buildings and structures
→ IS 875 : Part I to V : 1987
- IRC for vehicle load etc. in Bridge structures

STRUCTURAL STEEL PRODUCTS

- FOLLOWING ARE STRUCTURAL STEEL PRODUCTS
- A) FLAT HOT ROLLED PRODUCTS
Plates, Flat bars, Sheets, strips
- B) HOT ROLLED SECTIONS-
Rolled shapes, hollow structural sections
- C) BOLTS
- D) WELDING ELECTRODES
- E) COLD ROLLED SHAPES

HOT ROLLED SECTIONS AND PRODUCTS CONSIST OF FOLLOWING

)

HOT ROLLED SECTIONS AND PRODUCTS CONSIST OF FOLLOWING

i) ROLLED BEAMS

Junior Beams (ISJB-JB-Indian Standard Junior Beams)

Light Weight Beams (ISLB-LB-Indian Standard Light Beams)

Medium Weight Beams (ISMB-MB- Indian Standard Medium Weight Beams)

Wide Flange Beams (ISWB-WB- Indian Standard Wide Flange Beams)

Heavyweight Beams/ Columns (ISSC-SB- Indian Standard Heavyweight Beams)

Column Sections (ISSC-SC- Indian Standard Column Sections)

ii) CHANNELS

Junior, Light, and Medium and Parallel Flange (ISJC, ISLC, ISMC, ISMCP)

iii) EQUAL ANGLES (IEA/ISA)

iv) Unequal Angles (ISA)

v) T SECTIONS (ISJT, ISLT, ISST, ISNT, ISHT)

vi) ROLLED BARS

Round (ISRO)

Square (ISSQ)

vii) Tubular Sections (ISLT, ISMT, ISHT)

viii) Plates (ISPL)

ix) Strips (ISST)

x) Flats (ISFI)

Different type of rolled sections are available in the market and their properties are given in IS handbook in SP-6, Indian Standard Junior Beam which is termed as JB also. So, Indian Standard Junior Beam (ISJB), Indian Standard Light Beam (ISLB) and Indian Standard Medium Weight Beam (ISMB), Indian Standard Wide Flange Beam (ISWB). So different type of I sections are available in the code. Indian Standard Heavy Weight Beam (ISHB), Indian standard column section are also available there.

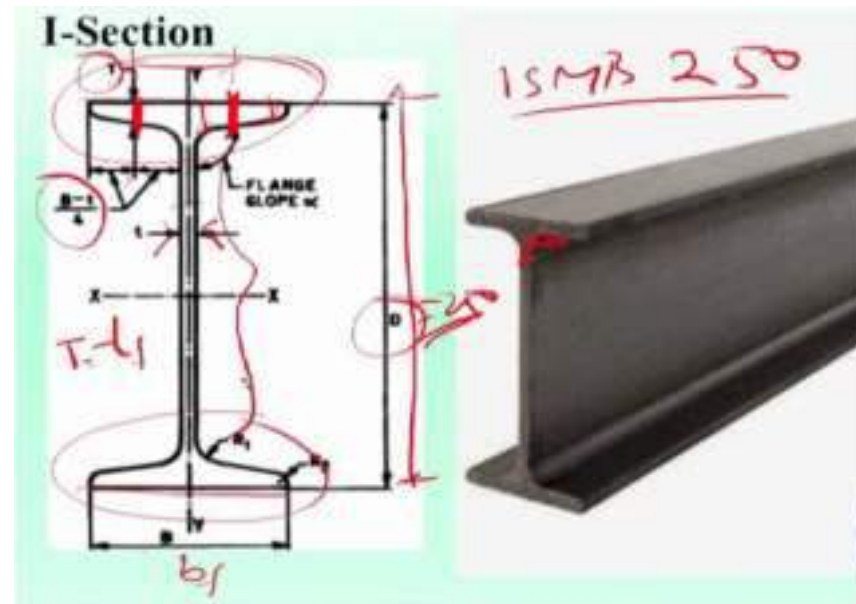

Now, the overall depth of I section is called D, in the SP-6, the properties of I sections are given. If you say ISMB 250 that means it will refer to a particular I section of medium beam ISMB, that 250 means the overall depth of the section will be 250. Therefore, this D will be 250 overall depth.

The width of flange is called B and sometimes we call b_f also, and web thickness is called t or t_w . Thickness of flange is measured at $(B - t)/4$ distance and we mention the thickness of the flange is T or t_f . So if you see in the SP-6, the properties of I section suppose if it is ISMB 250 then its depth is 250, its weight, its cross sectional area and the geometrical properties everything is mentioned there. Not only the geometrical properties, but also I_{xx} , (moment of inertia about x-axis), I_{yy} (moment of inertia about y-axis), R_{xx} (radius of gyration about x-axis), R_{yy} (radius of gyration about y-axis), section modulus Z_e , Z_p , gauge distance can be found. Therefore, that gauge distance is also standard for particular section. So all the relevant properties can be found out from that code.

Channel – Sections

Indian Standard Junior Channel (ISJC) – JC

Indian Standard Light Channel (ISLC) – LC

Indian Standard Medium Weight (ISMC) – MC

Indian Standard parallel flange Channel (ISMCP)-MCP

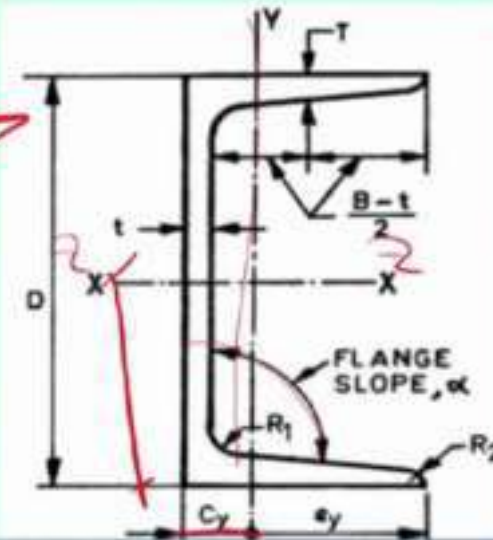
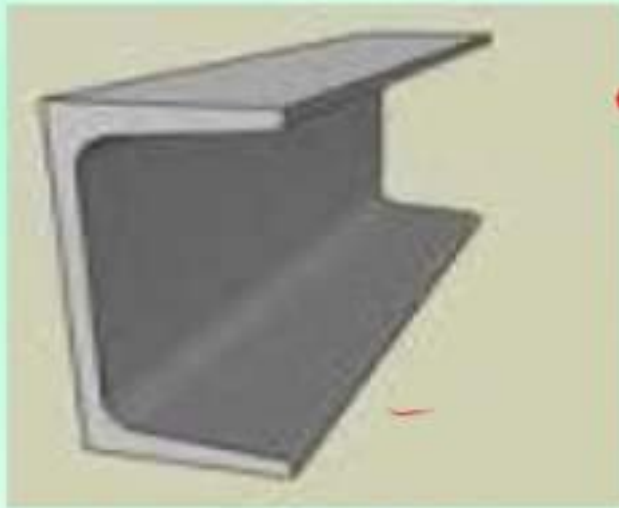

This channel section are mainly used for column. Indian standard junior channel (ISJC), ISLC Indian standard light channel (ISLC) Indian standard medium weight channel ISMC, different types of channel section are available in code. Here, ISMC 400 means the overall depth D will be 400. Once depth is known, other properties can be found out from SP-6. The width of the flange is termed as b_f and the thickness of the flange T or t_f is defined at a distance $(B-t)/4$, t_w is the thickness of web, R_1 and R_2 are the radius of curvature. Then C_{xx} , C_{yy} , flange slop, α are also given in SP-6. In the code, ZZ is written in place of XX , so I_{xx} is represented by I_{zz} .

Angle – Sections

Indian Standard Equal Angel (ISA)

ISA 90x90xL

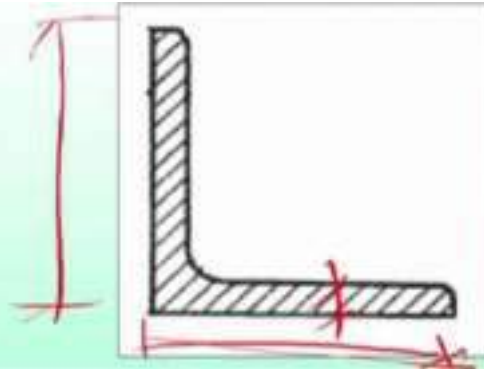

Angle sections are of two types, one is Indian standard equal angle and another is Indian standard unequal angle. Equal angle means leg length of both of the legs are same, but if leg lengths are unequal then it is unequal angle. So standard way of writing is ISA 90 × 90 × 6, that means both of the leg length is 90, thickness of the leg is 6 mm.

Indian Standard Unequal Angel (ISA)



Angle section

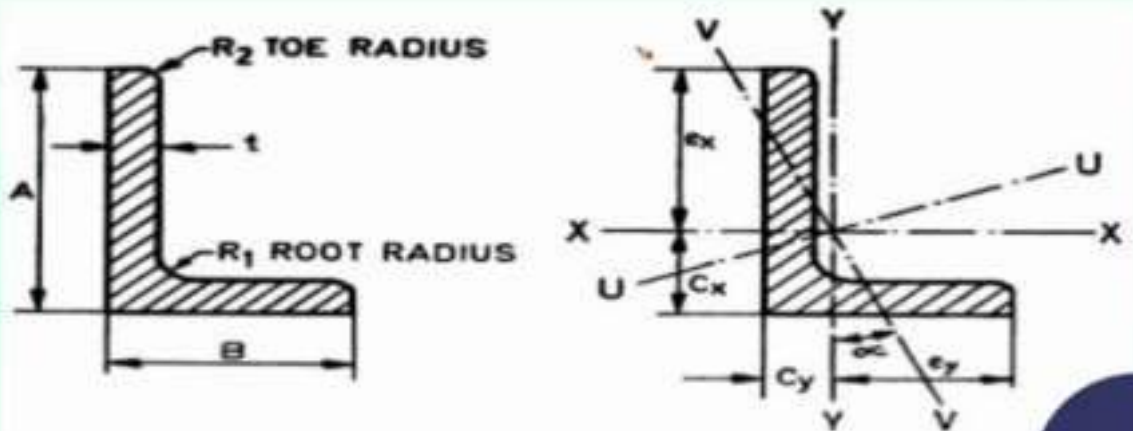

Tee – Sections

Indian Standard Normal Tee Bars (ISNT) – ISNT – NT

Indian Standard Deep Tee Bars (ISDT) – ISDT – DT

Indian Standard Light Tee Bars (ISLT) – ISLT – LT

Indian Standard Medium Tee Bars (ISMT) – ISMT – MT

Indian Standard Heavy Tee Bars (ISHT) – IS

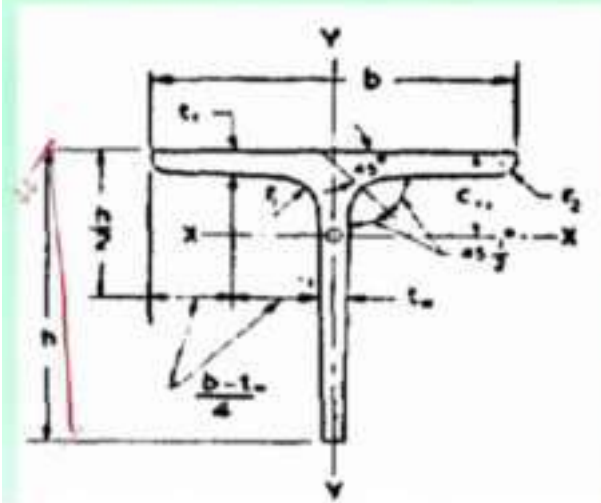

Tee section, Indian standard normal Tee section and in case of Tee section, the total h is the depth.

Rolled Steel Bar Section

Indian Standard Round Section-ISRO



Indian Standard Square Section-ISSQ



There are rolled steel bars, which is called Indian Standard Round Section (ISRO) and this is Indian Standard Square Section (ISSQ).

Rolled Steel Sections are designated as follows
ISRO100 means a round section of diameter 100mm,
while ISSQ50 means a square section each side of which is 50mm.

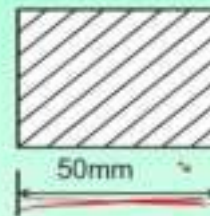
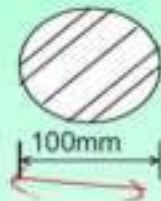

ISRO100 means it is a round section of diameter 100, again ISSQ50 means it is a square section of each side 50 mm. So, this is how it is designated.

Rolled Steel sheets & strip

Indian Standard Steel Sheet Section- ISSH-SH

Indian Standard Steel Strip Section- ISST-ST



Rolled steel flats are designated by width of the section in mm followed by the letter F & thickness. Thus, 50 F 8 means a flat of width 50 mm & thickness of 8 mm.

Then rolled steel sheet and strips are also used, those are termed as Indian Standards steel sheet section and Indian Standard steel strip section. 50 F 8 represent a flat of width 50 mm and thickness of 8 mm are used.

Square hollow section

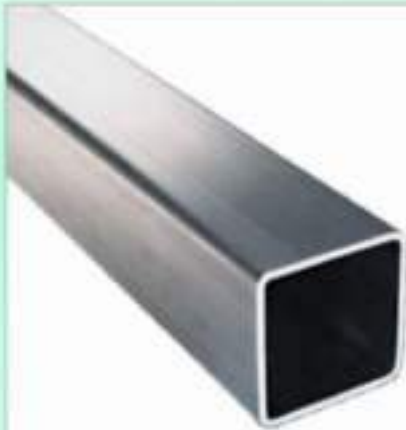

Hollow section pipe



Square hollow sections and hollow pipe sections are also used in design of steel members. So in this first lecture it is shown that different Indian rolled sections are available for designing and their geometrical properties are given in SP-6 which will be frequently used for design of structural members.

DESIGN METHODS, LOADS

Dr. G.C. BEHERA

DESIGN

BASIS FOR DESIGN

The bases of the design are given in Section 3.1 of IS 800:2007. It is as follows.

Design Objective

- The objective of design, as outlined in Cl.3.1.1 of IS 800:2007, is the achievement of an acceptable probability that structures will perform satisfactorily for the intended purpose during the design life. With an appropriate degree of safety, they should sustain all the loads and deformations, during construction and use and have adequate resistance to certain expected accidental loads and fire. Structure should be stable and have alternate load paths to prevent disproportionate overall collapse under accidental loading.

Methods of Design

- Method of Design of steel structures is given in Cl. 3.1.2 of IS 800:2007. In the previous version of the code, the design of steel structures was essentially using Working Stress Method. But IS 800:2007 permits us to design the structure to satisfy the various Limit States. It also advocates the use of Working Stress Method only to the situations where Limit State cannot be conveniently employed. As per Cl. 3.1.2.1 of IS 800:2007, Structure and its elements shall normally, be designed by the limit state method. Account should be taken of accepted theories, experimental information and experience and the need to design for durability. This clause admits that calculations alone may not produce Safe, serviceable and durable structures. Suitable materials, quality control, adequate detailing and good supervision are equally important. As per Cl. 3.1.2.2 of IS 800:2007, where the limit states method cannot be conveniently adopted; the working stress design (Section 11 of IS 800:2007) may be used.

Design Process

- Clause 3.1.3 of IS 800:2007 specifies structural design, including design for durability, construction and use should be considered as a whole. The realization of design objectives requires compliance with clearly defined standards for materials, fabrication, erection and in-service maintenance.
- **LOADS AND FORCES**
- Clause 3.2 of IS 800:2007 specifies the various loads and forces that has to be considered while performing the design of steel structures. As per Cl. 3.2.1 of IS 800:2007, for the purpose of designing any element, member or a structure, the following loads (actions) and their effects shall be taken into account, where applicable, with partial safety factors and combinations (Cl. 5.3.3 of IS 800:2007).
 - **(a) Dead loads; (Cl. 3.2.1.1 of IS 800:2007)**
Dead loads should be assumed in design as specified in IS 875 (Part 1).
 - **(b) Imposed loads (Cl. 3.2.1.2 of IS 800:2007)**
(live load, crane load, snow load, dust load, wave load, earth pressures, etc);
IS 800:2007 specifies in Cl.3.2.1.2 that imposed loads for different types of occupancy and function of structures shall be taken as recommended in IS 875 (Part 2). Imposed loads arising from equipment, such as cranes and machines should be assumed in design as per manufacturers/suppliers data (Cl. 3.5.4 of IS 800:2007). Snow load shall be taken as per IS 875 (Part 4).
 - **(c) Wind loads; (Cl. 3.2.1.3 of IS 800:2007)**
Wind loads on structures shall be taken as per the recommendations of IS 875 (Part 3).

LOADS

- (d) **Earthquake loads; (Cl. 3.2.1.4 of IS 800:2007)**
Earthquake loads shall be assumed as per the recommendations of IS 1893 (Part 1).
- (e) **Erection loads; (Cl. 3.3 of IS 800:2007)**
- All loads required to be carried by the structure or any part of it due to storage or positioning of construction material and erection equipment, including all loads due to operation of such equipment shall be considered as erection loads. The structure as a whole and all parts of the structure in conjunction with the temporary bracings shall be capable of sustaining these loads during erection.
- (f) Accidental loads such as those due to blast, impact of vehicles, etc; and
- (g) Secondary effects due to contraction or expansion resulting from temperature changes, differential settlements of the structure as a whole or of its components, eccentric connections, rigidity of joints differing from design assumptions

Load Combinations

- Load combinations for design purposes shall be those that produce maximum forces and effects and consequently maximum stresses and deformations. The following combination of loads with
- appropriate partial safety factors as given in Table 4 of IS 800:2007 may be considered. The table is reproduced here as Table 2 for ready reference.
- a) Dead load + imposed load,
- b) Dead load + imposed load+ wind or earthquake load,
- c) Dead load + wind or earthquake load, and
- d) Dead load+ erection load.
- The effect of wind load and earthquake loads shall not be considered to act simultaneously. The load combinations are outlined in detail in Cl. 3.5 of IS 800:2007.

LOAD COMBINATION

Table 2 Partial safety factors for loads for limit states

Combination (1)	Limit State of Strength					Limit State of Serviceability			
	DL (2)	LL ¹ Leading (3) / Accompanying (4)		WL/EL (5)	AL (6)	DL (7)	LL ¹ Leading (8) / Accompanying (9)		WL/EL (10)
DL+LL+CL	1.5	1.5	1.05	—	—	1.0	1.0	1.0	—
DL+LL+CL+ WL/EL	1.2	1.2	1.05	0.6	—	1.0	0.8	0.8	0.8
DL+WL/EL	1.2	1.2	0.53	1.2	—	—	—	—	—
DL+ER	1.5 (0.9) ^b	—	—	1.5	—	1.0	—	—	1.0
DL+LL+AL	1.2 (0.9) ^b	1.2	—	—	—	—	—	—	—
	1.0	0.35	0.35	—	1.0	—	—	—	—

CLASSIFICATION OF CROSS-SECTIONS

- Plate elements of a cross-section may buckle locally due to compressive stresses. The local buckling can be avoided before the limit state is achieved by limiting the width to thickness ratio of each element of a cross-section subjected to compression due to axial force, moment or shear. When plastic analysis is used, the members shall be capable of forming plastic hinges with sufficient rotation capacity (ductility) without local buckling, to enable the redistribution of bending moment required before formation of the failure mechanism. When elastic analysis is used, the member shall be capable of developing the yield stress under compression without local buckling. On basis of the above, Cl. 3.7 of IS 800:2007 categorizes the sections into four classes as follows.
- When different elements of a cross-section fall under different classes, the section shall be classified as governed by the most critical element. The maximum value of limiting width to thickness ratios of elements for different classifications of sections are given in Table 2 of IS 800:2007

CLASSIFICATION OF CROSS-SECTIONS

- **Class 1 (Plastic)**
Cross-sections which can develop plastic hinges and have the rotation capacity required for failure of the structure by formation of plastic mechanism fall under this category. The width to thickness ratio of plate elements shall be less than that specified under Class 1 (Plastic), in Table 2 of IS 800:2007.
- **Class 2 (Compact)**
Cross-sections which can develop plastic moment of resistance, but have inadequate plastic hinge rotation capacity for formation of plastic mechanism, due to local buckling come under this class. The width to thickness ratio of plate elements shall be less than that specified under Class 2 (Compact), but greater than that specified under Class 1 (Plastic), in Table 2 of IS 800:2007.
- **Class 3 (Semi-compact)**
Cross-sections in which the extreme fiber in compression can reach yield stress but can not develop the plastic moment of resistance, due to local buckling. The width to thickness ratio of plate elements shall be less than that specified under Class 3 (Semi-compact), but greater than that specified under Class 2 (Compact), in Table 2 of IS 800:2007.
- **Class 4 (Slender)**
Cross-sections in which the elements buckle locally even before reaching yield stress. The width to thickness ratio of plate elements shall be greater than that specified under Class 3 (Semicompact), in Table 2 of IS 800:2007. In such cases, the effective sections for design shall be calculated either by following the provisions of IS 801 to account for the post-local-buckling strength or by deducting width of the compression plate element in excess of the semi-compact section limit.

Table 2 Limiting Width to Thickness Ratio

(Clauses 3.7.2 and 3.7.4)

Compression Element (1)		Ratio (2)	Class of Section			
			Class 1 Plastic (3)	Class 2 Compact (4)	Class 3 Semi-compact (5)	
Outstanding element of compression flange	Rolled section	b/t_f	9.4ϵ	10.5ϵ	15.7ϵ	
	Welded section	b/t_f	8.4ϵ	9.4ϵ	13.6ϵ	
Internal element of compression flange	Compression due to bending	b/t_f	29.3ϵ	33.5ϵ	42ϵ	
	Axial compression	b/t_f	Not applicable			
Web of an I, H or box section	Neutral axis at mid-depth		d/t_w	84ϵ	105ϵ	126ϵ
	Generally	If r_1 is negative:	d/t_w	$\frac{84\epsilon}{1+r_1}$	$\frac{105.0\epsilon}{1+r_1}$	$\frac{126.0\epsilon}{1+2r_1}$
		If r_1 is positive :	d/t_w	but $\leq 42\epsilon$	$\frac{105.0\epsilon}{1+1.5r_1}$ but $\leq 42\epsilon$	but $\leq 42\epsilon$
	Axial compression		d/t_w	Not applicable		42ϵ
Web of a channel		d/t_w	42ϵ	42ϵ	42ϵ	
Angle, compression due to bending (Both criteria should be satisfied)		b/t d/t	9.4ϵ 9.4ϵ	10.5ϵ 10.5ϵ	15.7ϵ 15.7ϵ	
Single angle, or double angles with the components separated, axial compression (All three criteria should be satisfied)		b/t d/t $(b+d)/t$	Not applicable		15.7ϵ 15.7ϵ 25ϵ	
Outstanding leg of an angle in contact back-to-back in a double angle member		d/t	9.4ϵ	10.5ϵ	15.7ϵ	
Outstanding leg of an angle with its back in continuous contact with another component		d/t	9.4ϵ	10.5ϵ	15.7ϵ	
Stem of a T-section, rolled or cut from a rolled I-or H- section		D/t_f	8.4ϵ	9.4ϵ	18.9ϵ	
Circular hollow tube, including welded tube subjected to: a) moment		D/t	$42\epsilon^2$	$52\epsilon^2$	$146\epsilon^2$	
b) axial compression		D/t	Not applicable		$88\epsilon^2$	

NOTES

1 Elements which exceed semi-compact limits are to be taken as of slender cross-section.

$$2 \epsilon = (250 / f_y)^{1/2}.$$

3 Webs shall be checked for shear buckling in accordance with 8.4.2 when $d/t > 67\epsilon$, where, b is the width of the element (may be taken as clear distance between lateral supports or between lateral support and free edge, as appropriate), t is the thickness of element, d is the depth of the web, D is the outer diameter of the element (see Fig. 2, 3.7.3 and 3.7.4).

4 Different elements of a cross-section can be in different classes. In such cases the section is classified based on the least favourable classification.

5 The stress ratio r_1 and r_2 are defined as:

$$r_1 = \frac{\text{Actual average axial stress (negative if tensile)}}{\text{Design compressive stress of web alone}}$$

$$r_2 = \frac{\text{Actual average axial stress (negative if tensile)}}{\text{Design compressive stress of overall section}}$$

TYPES OF ELEMENTS

- IS 800:2007 classifies elements into three types, as per Cl. 3.7.3., as follows.
- **Internal elements**
These are elements attached along both longitudinal edges to other elements or to longitudinal stiffeners connected at suitable intervals to transverse stiffeners, for example, web of I-section and flanges and web of box section.
- **Outside elements or outstands**
- These are elements attached along only one of the longitudinal edges to an adjacent element, the other edge being free to displace out of plane, for example flange overhang of an I-section, stem of T section and legs of an angle section.
- **Tapered elements**
These may be treated as flat elements having average thickness as defined in SP 6 (Part 1).
- **MAXIMUM EFFECTIVE SLENDERNESS RATIO**
The maximum effective slenderness ratio, as per Cl. 3.8 of IS 800:2007, KL/r values of a beam, strut or tension member shall not exceed those given in Table 3 of IS 800:2007. 'KL' is the effective length of the member and 'r' is appropriate radius of gyration based on the effective section as defined in Cl. 3.6.1 of IS 800:2007. This data is reproduced here in Table .

Member	Maximum Effective Slenderness Ratio (KL/r)
A member carrying compressive loads resulting from dead loads and imposed loads	180
A tension member in which a reversal of direct stress occurs due to loads other than wind or seismic forces	180
A member subjected to compression forces resulting only from combination with wind/earthquake actions, provided the deformation of such member does not adversely affect the stress in any part of the structure	250
Compression flange of a beam against lateral torsional buckling	300
A member normally acting in a tie in a roof truss or a bracing system not considered effective when subject to possible reversal of stress into compression resulting from the action of wind or earthquake forces	350
Members always under tension (other than pre-tensioned members)	400

LIMIT STATE DESIGN

- The current revision of the code of practice, IS 800:2000, recommends limit state method for design of structures using hot rolled sections. This method is outlined in section 5 of IS 800:2007. However, it retained working stress method of design which was the design method for decades. But the scope of the working stress method is limited to those situations where limit state method cannot be conveniently employed.
- **3.1. BASIS FOR DESIGN**
- In the limit state design method, the structure shall be designed to withstand safely all loads likely to act on it throughout its life. It shall not suffer total collapse under accidental loads such as from explosions or impact or due to consequences of human error to an extent beyond the local damages. The objective of the design is to achieve a structure that will remain fit for use during its life with acceptable target reliability. In other words, the probability of a limit state being reached during its lifetime should be very low. The acceptable limit for the safety and serviceability requirements before failure occurs is called a limit state. In general, the structure shall be designed on the basis of the most critical limit state and shall be checked for other limit states. Steel structures are to be designed and constructed to satisfy the design requirements with regard to stability, strength, serviceability, brittle fracture, fatigue, fire, and durability such that they meet the following: a) Remain fit with adequate reliability and be able to sustain all actions (loads) and other influences experienced during construction and use; b) Have adequate durability under normal maintenance; c) Do not suffer overall damage or collapse disproportionately under accidental events like explosions, vehicle impact or due to consequences of human error to an extent beyond local damage. The potential for catastrophic damage shall be limited or avoided by appropriate choice of one or more of the following: • Avoiding, eliminating or reducing exposure to hazards, which the structure is likely to sustain. • Choosing structural forms, layouts and details and designing such that: i) the structure has low sensitivity to hazardous conditions; and ii) the structure survives with only local damage even after serious damage to any one individual element by the hazard.
- • Choosing suitable material, design and detailing procedure, construction specifications, and control procedures for shop fabrication and field construction as relevant to the particular structure.

- The following conditions may be satisfied to avoid a disproportionate collapse:
- The building should be effectively tied together at each principal floor level and each column should be effectively held in position by means of continuous ties (beams) nearly orthogonal, except where the steel work supports only cladding weighing not more than 0.7 kN/m² along with imposed and wind loads.
- These ties must be steel members such as beams, which may be designed for other purposes, steel bar reinforcement anchoring the steel frame to concrete floor or steel mesh reinforcement in composite slab with steel profiled sheeting directly connected to beam with shear connectors. These steel ties and their end connections should be capable of resisting factored tensile force not less than the factored dead and imposed loads acting on the floor area tributary to the tie nor less than 75 kN. Such connection of ties to edge column should also be capable of resisting 1 percent of the maximum axial compression in the column at the level due to factored dead and imposed loads. All column splices should be capable of resisting a tensile force equal to the largest of a factored dead and live load reaction from a single floor level located between that column splice and the next column splice below that splice. Lateral load system to resist notional horizontal loads prescribed in Cl. 4.3.6 of IS 800:2007 should be distributed throughout the building in nearly orthogonal directions so that no substantial portion is connected at only one point to such a system. Precast concrete or other heavy floor or roof units should be effectively anchored in the direction of their span either to each other over the support or directly to the support. Where the above conditions to tie the columns to the floor adequately are not satisfied each storey of the building should be checked to ensure that disproportionate collapse would not precipitate by the notional removal, one at a time, of each column. Where each floor is not laterally supported by more than one system, check should be made at each storey by removing one such lateral support system at a time to ensure that disproportionate collapse would not occur. The collapse is considered disproportionate, if more than 15 percent of the floor or roof area of 70 m² collapse at that level and at one adjoining level either above or below it, under a load equal to 1.05 or 0.9 times the dead load, 0.33 times temporary or full imposed load of permanent nature (as in storage buildings) and 0.33 times wind load acting together.

DESIGN METHODS



So, if we see stress strain diagram in case of steel we consider the structure to withstand load up to yield strength (f_y), that means the characteristic strength of the member. So up to Yield strength we consider and then we divide it with some factor of safety and then we get the Permissible stress.

Working Stress Method:

Safety is ensured by limiting the stress of the material. The material is assumed to behave in linear elastic manner. In this approach the stress-strain behaviour is considered to be linear.

Permissible stress < (Yield stress / Factor of safety)

Details at: IS 800 – 1984.

Permissible stress in steel structural members

Types of stress	Notation	Permissible stress (Mpa)	Factor of safety
Axial tension	σ_{at}	$0.6f_y$	1.67
Axial compression	σ_{ac}	$0.6f_y$	1.67
Bending tension	σ_{bt}	$0.66f_y$	1.515
Bending compression	σ_{bc}	$0.66f_y$	1.515
Average shear stress	τ_{av}	$0.4f_y$	2.5
Bearing stress	σ_p	$0.75f_y$	1.33

USM: It is also referred to Plastic Design Method. In this case the limit state is attained when the members reach plastic moment strength M_p , and the structure is attained into a mechanism. The safety measure of the structure is taken care of by an appropriate choice of **load factor**. It is multiplied to the working load and it is checked w.r.t to the ultimate load corresponding to the member.

$$\sum (\text{Working Load} \times \text{Load Factor}) \leq \text{Ultimate Load}$$

LSM: In limit state design method, the structure is designed in such a way that it can safely withstand all kind of loads that may act on the structure under consideration in its entire design life. In this approach, the science of reliability based design was developed with the objective of providing a rational solution to the problem of adequate safety. **Uncertainty is reflected in loading and material strength.**

Than another method which we considered earlier was Ultimate Strength Method. It is basically a plastic design method, in this case the Limit State is attained when the members reach plastic moment. That means in this case we go up to say f_u , so up to this we consider and then we design and of course, we also multiply some load factor factor with the working load to get the Ultimate Load. In this method, we do not consider the serviceability condition that means whether the occupant feel discomfort or not, whether excessive deflection is coming or not that we do not bother. So from the users point of view it is not advisable, so this method also became nowadays obsolete.

- Limit State Method the structure is designed in such a way that it can safely withstand all kind of loads that may act under consideration in its entire design life. So that we have to consider the science of reliability based design with the objective of providing a rational solution to the problem of adequate safety, that means we are not compromising with the safety and uncertainty is reflected in loading and material strength. So what we do here, we consider up to ultimate strength and we make use of some factor of safety to get the permissible strength or the member.
- So here we use some sort of factor of safety to ensure the uncertainty factor also we use the load factor as we are not sure that what will be the actual load in the site. We try to find out the maximum means worst possible combination and we multiply with some factor which was obtained from reliability based method and then we try to design with that factored load this is Limit State Method but this is Limit State of strength another is Limit State of Serviceability that also we have to consider.
- So in case of Limit State of Strength we have to consider the stability with Stability against Overturning and Sway Stability that we have to keep in mind also we have to keep in mind the Fatigue and Plastic Collapse. Therefore, Limit State of Strength depends on this few aspects.

Limit State of Strength:

These are associated with the failure of the structure under the action of worst possible combination of loads along with proper partial safety factor that may lead to loss of life and property. As provided in **IS 800: 2007**, Limit state of strength includes –

- Loss of equilibrium of the structure as a whole or in part.
- Loss of stability of the structure.
- Failure due to excess deformation or rupture.
- Fracture due to fatigue.
- Brittle fracture.

So in IS 800: 2007 the Limit State of Strength includes this few things which we have to keep in mind like Loss of equilibrium of the structure as a whole or in part, loss of stability of the structure, then failure due to excess deformation or rupture, fracture due to fatigue and brittle fracture. So, these are associated with the failure which we have to keep in mind and we have to design under the worst possible combination.

Limit State Serviceability



- **Limit State of Strength, another is Limit State Serviceability.** So Limit State of Serviceability when we check Deflection limit, then Vibration limit, Durability consideration and also Fire resistance. So these are few aspects from Limit State Serviceability point of view, so we have to take care we have to keep in mind this limit and we have to design the structural member keeping all these limits in our mind.

Limit State of Serviceability:

These are associated with the discomfort faced by the user while using the structure.

- Excess deflection or deformation of the structure.
- Excess vibration of the structure causing discomfort to the commuters.
- Repairable damage or crack generated due to fatigue.
- Corrosion and durability

- Limit State of Serviceability will be associated with the discomfort faced by the user while using the structure that is one is excess deflection or deformation of the structure.
- Because suppose in structure we are residing in a tall building towards the top floor then due to vibration means due to cyclone or due to earthquake the building may vibrate considerably. but we know from Limit State of Strength we know that design has been done in such a way it will not collapse but if you do not consider the Limit State of Serviceability then we are allowing large deflection, so if deflection is more than the occupant will be afraid of staying there because of this large vibration.
- So in such case we have to consider the occupants discomfort ability and we have to take certain measure so that vibration can be reduced, excessive deflection or deformation of the structure can be reduced. So this has to be taken care.
- Then excessive vibration of the structure causing discomfort to the commuters, repairable damage or crack generated due to fatigue that also we have to keep in mind that we should take care of damage or crack and of course corrosion and durability that also we have to keep in mind. So these are the some parameters which are associated with the Limit State Serviceability.

Partial Safety Factor for Load **(Clause 5.3.3, Table 4, IS 800: 2007)**

$$Q_d = \sum_k \gamma_{fk} Q_{ck}$$

Where, γ_f = the partial safety factor for kth load or load effect, Q_c = Characteristic load or load effect, Q_d = Design load or load effect.

Note

Characteristic values (loads/stresses) are defined as the values that are not expected to be exceeded within the life of the structure with more than 5% probability.

Partial Safety Factor for Loads, γ_f (Table 4, IS 800: 2007)

Combinations	Limit State of Strength					Limit State of Serviceability			
	DL	LL		WL/ EL	AL	DL	LL		WL/ EL
		Leading	Accompanying				Leading	Accompanying	
DL+LL+CL	1.5	1.5	1.05	-	-	1.0	1.0	1.0	-
DL+LL+CL	1.2	1.2	1.05	0.6	-	1.0	0.8	0.8	0.8
+WL/EL	1.2	1.2	0.53	1.2	-	-	-	-	-
DL+WL/EI	1.5 (0.9)	-	-	1.5	-	1.0	-	-	1.0
DL+ER	1.2 (0.9)	1.2	-	-	-	-	-	-	-
DL+LL+AL	1.0	0.35	0.35	-	1.0	-	-	-	-

Notes:

- (i) DL=dead load, LL=imposed (live) load, CL=crane load, WL=wind load, EL=earthquake load, AL=accidental load.
- (ii) During simultaneous action of different live loads one which has greater effect on the member under consideration is considered as the leading live load.
- (iii) Value in the bracket should be considered when dead load contributes to the stability against overturning or it causes reduction in stress due to other loads.

Partial Safety Factor for Material

Partial safety factor for material

$$S_d = S_u / \gamma_m$$

Where, γ_m = Partial safety factor for material as given in Table 1.5.

S_u = Ultimate strength of the material, S_d = Design strength of the material.

Generally, a factor of unity (one) or less is applied to the resistances of the material.

Partial safety factor for material, γ_m (Table 5, IS 800: 2007)

Definition	Partial Safety Factor	
Resistance governed by yielding, γ_{m0}	1.10	
Resistance of member to buckling, γ_{m0}	1.10	
Resistance governed by ultimate stress, γ_{m1}	1.25	
Resistance of connection	Shop Fabrication	Field Fabrication
(a) Bolts, friction type, γ_{mf}	1.25	1.25
(b) Bolts, bearing type, γ_{mb}	1.25	1.25
(c) Rivets, γ_{mr}	1.25	1.25
(d) Welds, γ_{mw}	1.25	1.50

Deflection Limits (Table 6, IS 800: 2007)

Type of Building	Deflection	Design Load	Member	Supporting	Maximum Deflection	
Industrial Buildings	Vertical	LL/WL	Purlins and girts	Elastic Cladding	Span/150	
				Brittle Cladding	Span/180	
		LL	Simple span	Elastic Cladding	Span/240	
				Brittle Cladding	Span/300	
		LL	Cantilever span	Elastic Cladding	Span/120	
				Brittle Cladding	Span/150	
		LL/WL	Rafters supporting	Profiled Metal sheeting	Span/180	
		Plastered sheeting		Span/240		
	CL (manual operation)	Gantry	Crane	Span/500		
	CL (electric operation up to 50t)	Gantry	Crane	Span/750		
	CL (electric operation over 50t)	Gantry	Crane	Span/1000		
	Lateral	No cranes		Column	Elastic Cladding	Height/150
					Brittle Cladding	Height/240
		Crane + wind		Gantry (lateral)	Crane (absolute)	Span/400
Relative displacement between rails supporting crane					10mm	
Gantry (Elastic cladding, pendant operated)					Height/200	
Crane + wind		Column/frame	Gantry (Brittle cladding, cab operated)	Height/400		

Table 6 Deflection Limits

Type of Building	Deflection	Design Load	Member	Supporting	Maximum Deflection	
(1)	(2)	(3)	(4)	(5)	(6)	
Industrial Buildings	Vertical	Live load/ Wind load	Purlins and Girts	Elastic cladding	Span/150	
				Brittle cladding	Span/180	
		Live load	Simple span	Elastic cladding	Span/240	
				Brittle cladding	Span/300	
		Live load	Cantilever span	Elastic cladding	Span/120	
				Brittle cladding	Span/150	
		Live load/ Wind load	Rafter supporting	Profiled Metal Sheeting	Span/180	
			Plastered Sheeting	Span/240		
		Lateral	Crane load (Manual operation)	Gantry	Crane	Span/500
	Crane load (Electric operation up to 50 t)		Gantry	Crane	Span/750	
Crane load (Electric operation over 50 t)	Gantry		Crane	Span/1 000		
	Lateral	No cranes	Column	Elastic cladding	Height/150	
				Masonry/Brittle cladding	Height/240	
				Crane (absolute)	Span/400	
	Lateral	Crane + wind	Gantry (lateral)	Relative displacement between rails supporting crane	10 mm	
		Crane+ wind	Column/frame	Gantry (Elastic cladding; pendent operated)	Height/200	
				Gantry (Brittle cladding; cab operated)	Height/400	
Other Buildings	Vertical	Live load	Floor and Roof	Elements not susceptible to cracking	Span/300	
				Elements susceptible to cracking	Span/360	
	Vertical	Live load	Cantilever	Elements not susceptible to cracking	Span/150	
				Elements susceptible to cracking	Span/180	
	Lateral	Wind	Building	Elastic cladding	Height/300	
	Wind	Inter storey drift	—	Storey height/300		

Load and Load Combinations

- Dead loads – [IS:875 (Part-1)]
- Imposed loads (i.e. Live loads, Crane loads etc) – [IS:875 (Part 2)]
- Wind loads – [IS:875 (Part-3)]
- Snow loads - [IS:875 (Part-4)]
- Temperature, Hydrostatic, Soil pressure, Fatigue, Accidental, Impact, Explosions etc and load combinations [IS:875 (Part-5)]
- Earthquake load – [IS:1893-2002 (Part-1)]
- Erection loads – [IS:800-2007 Cl. 3.3]
- Other secondary effects such as temperature change, differential settlement, eccentric connections etc.



STRUCTURAL STEEL PRODUCTS

- ROLLED BEAMS
- INDIAN STANDARD JUNIOR BEAMS-ISJB
- INDIAN STANDARD LIGHT WEIGHT BEAMS-ISLB
- INDIAN STANDARD MEDIUM WEIGHT BEAMS –ISMB
- IND LIGHT BEAMS/COLUMNS -ISMB

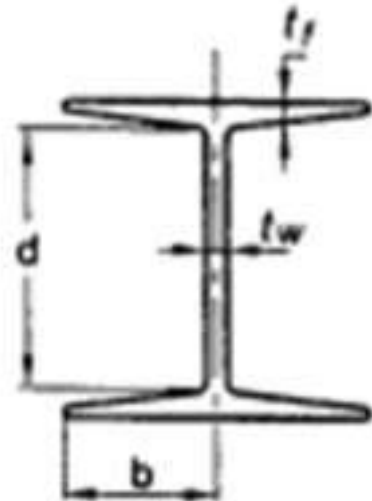

ROLLED BEAMS
AND COLUMNS

CHANNELS

- JUNIOR, LIGHT MEDIUM ISJC, ISLC, ISMC

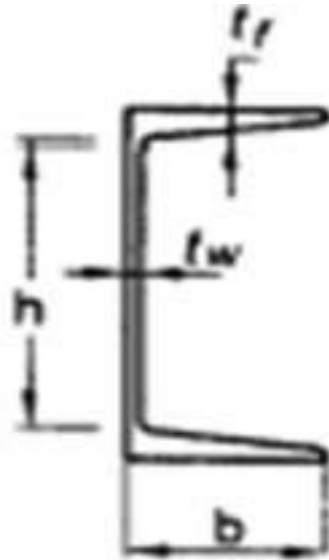

ROLLED
CHANNELS

(EQUAL ANGLES-ISEA/ISA)
UNEQUAL ANGLES-ISA

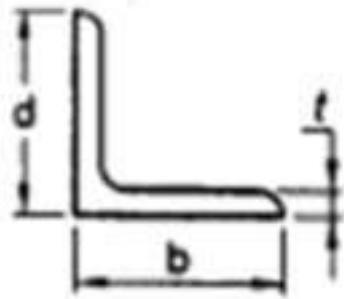

SINGLE ANGLES

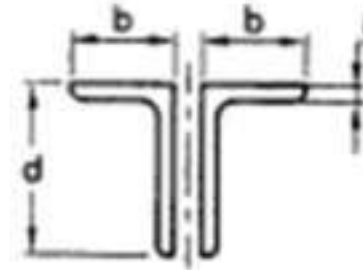

DOUBLE ANGLES
(BACK TO BACK)

T SECTIONS

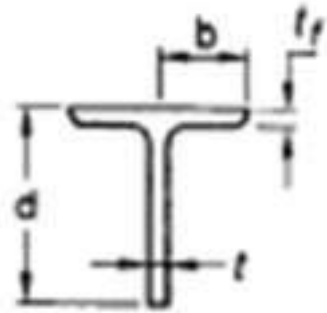

TEES

CONNECTIONS

- REQUIREMENT:
- To combine two members to act as a single member and to share the loads. Various connections are available for joining members in case of RCC structure. Generally, we used to connect RCC members by casting them in-situ. But in case of steel members different type of steel roll sections are available in the market. The steel roll sections are need to join together and that can be done by applying various types of connections, like rivet connections, bolt connections, weld connections and combination of those two or three.

JINTS REQUIRED

Joints are required

- Beam and Column
- Beam and Beam
- Beam and Cross beam
- Column and Column
- Column and Bracket
- Column and Caps
- Base plate of Trusses
- Truss member connection through Gussets
- Purlin and rafters
- Wind Braces and Columns

TYPE OF FABRICATION OR JOINTS

- rivet joints,
- bolt joints
- weld joints.

combine of two or three of the above means in a particular joint we can make use of rivet and bolt, bolt or weld, or bolt and rivet connection.

REQUIREMENT OF GOOD CONNECTION

- A. EASY INSTALLATION
- B. EASY IN INSPECTION
- C. AFTER JOINING SHOULD BE RIGID TO AVOID STRESS VARIATION

RIVET CONNECTION

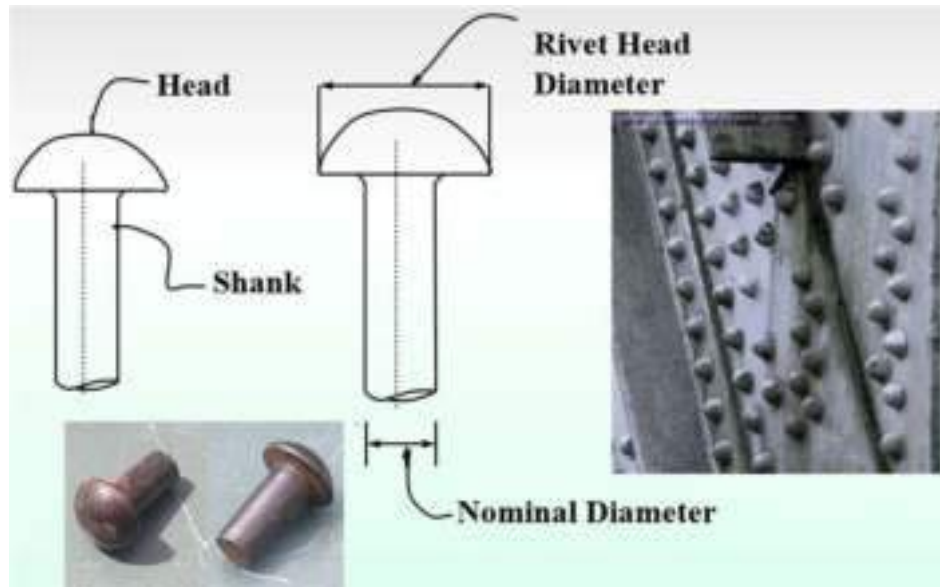

Now coming to rivet connections we know rivets are inserted in the plates to join together. With different plates and by adding heat we can insert. A typical rivet joint is shown in Fig. , where different members are connected to plate by riveting and in the parts of rivet, the upper part is called head and the lower cylindrical part is called shank. Shank has particular length depending on the thickness of the plates, so it can vary accordingly.

Different type of heads is available and according to that different name of the RIVETS are given. Now this rivet head has a particular diameter which is called rivet head diameter and the diameter of shank is called nominal diameter or rivet diameter or shank diameter.

Depending on the size of nominal diameter the strength of rivet can be calculated on the basis of the type of material used and accordingly we can calculate the rivet strength.

Advantages of Riveted connections:

- i. Ease of riveting process.
- ii. Rivet connection is permanent in nature.
- iii. Cheaper fabrication cost.
- iv. Low maintenance cost.
- v. Dissimilar metals can also be joined; even non-metallic joints are possible with riveted joints.
- vi. Rivet connection is possible without electricity in remote area.

In case of welded connection, we need electricity otherwise it will be difficult to join the members but in case of rivet connections, only through application of heat we can joined.

Disadvantages of Rivet Connection:

- i. Necessity of pre-heating the rivets prior to driving
- ii. Create high level of noise at the site of construction
- iii. Skilled work necessary for inspection of connection
- iv. Cost involved in careful inspection and removal of poorly installed rivets
- v. High labor cost

So because of certain disadvantages nowadays riveting connections are becoming absolute, mainly because of noise and because of generation of heat and difficulty to change the improper insertion of the rivet.

ASSUMPTIONS IN RIVET CONNECTION

- i. Friction between the plates is neglected.
- ii. The shear stress is uniform on the cross section of the rivet.
- iii. The distribution of direct stress on the portion of the plates between the rivet holes is
 - uniform.
- iv. Rivets in group subjected to direct loads share the load equally.
- v. Bending stress in the rivet is neglected.
- vi. Rivets fill completely the holes in which they are driven
- vii. Bearing stress distribution is uniform and contact area is $d \times t$, where d is the nominal diameter and t is the thickness of the plate.
- As rivet connection is becoming absolute nowadays therefore in new code in IS:800-2007 details of rivet design is not given in Limit State Method however in case of bolt and weld connection it has been described explicitly.

Disadvantages of Rivet Connection:

- i. Necessity of pre-heating the rivets prior to driving
- ii. Create high level of noise at the site of construction
- iii. Skilled work necessary for inspection of connection
- iv. Cost involved in careful inspection and removal of poorly installed rivets
- v. High labor cost

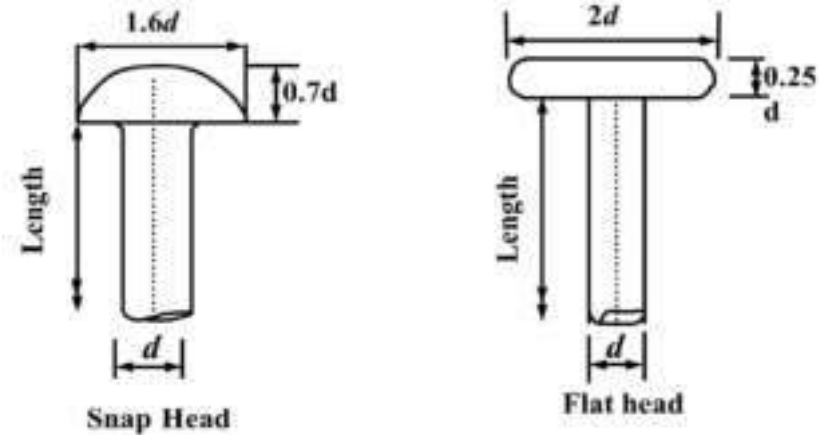
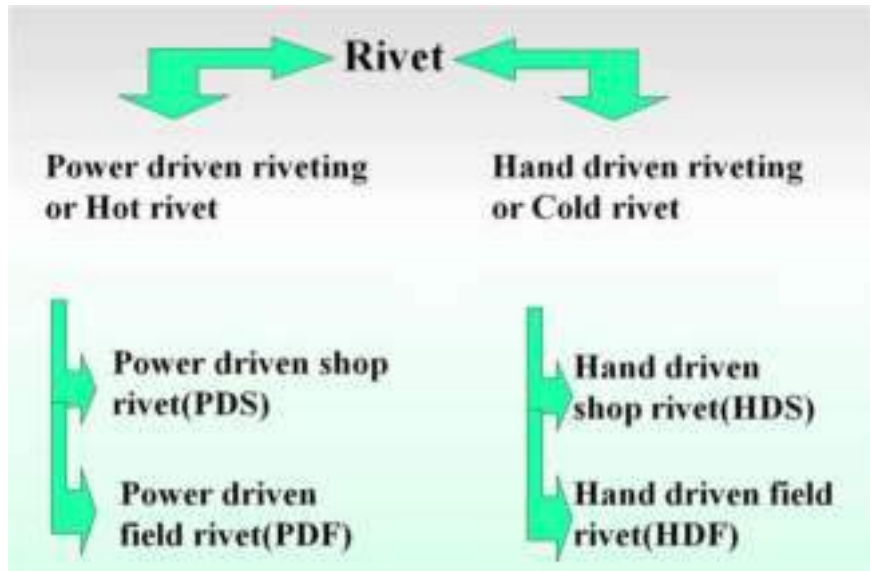

Now commonly used rivets are like snap head where the head dimensions are represented by the shank diameter. If diameter of shank is d then we can consider that the diameter of rivet head is $1.6d$ and the height of the rivet head is $0.7d$. So with different height and diameter different types of rivet heads are available. Two types of rivet are generally used as shown in fig.

The length of the shank is called rivet length. In this case we should remember that there is two type of diameter, one is rivet diameter (nominal diameter) another is hole diameter (gross diameter). Gross diameter is little higher than the rivet diameter, and it is sometimes 1.5 or 2 mm more than the nominal diameter.

ASSUMPTIONS IN RIVET CONNECTION

- i. Friction between the plates is neglected.
- ii. The shear stress is uniform on the cross section of the rivet.
- iii. The distribution of direct stress on the portion of the plates between the rivet holes is uniform.
- iv. Rivets in group subjected to direct loads share the load equally.
- v. Bending stress in the rivet is neglected.
- vi. Rivets fill completely the holes in which they are driven
- vii. Bearing stress distribution is uniform and contact area is $d \times t$, where d is the nominal diameter and t is the thickness of the plate.

BOLT CONNECTION

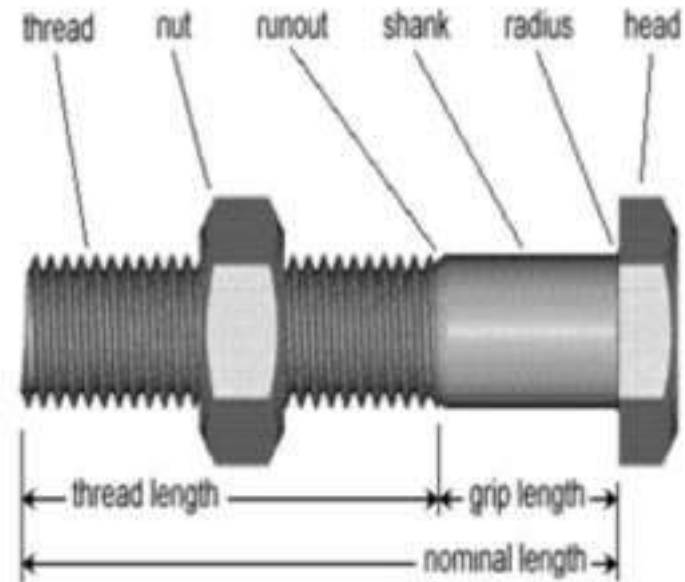

Clause-2.4: Bolts, nuts and washers shall conform as appropriate to:
IS 1363-1967, IS 1364-1967, IS-1367-1967, IS-3640-1967, IS 3757-1972, IS 6623-1972 and IS 6639-1972

BOLT CONNECTION

- **Advantages of bolt connection:**
- i. Less manpower unlike rivet connection
- ii. High strength bolts are much stronger than rivet. Hence, bolted connections need less fasteners than rivet joints mean less holes in the plate resulting stronger connection.
- iii. Bolting operation is much faster
- iv. Bolting operation is very silent in contrast to hammering noise in riveting
- v. Bolting is a cold process; no risk of fire
- vi. Bolt can be removed, replaced or retightened easily in the event of faulty bolting or damaged bolts due to accidents/hazards
- **Disadvantages of bolt connection:**
- i. Bolted connections have lesser strength in axial tension as the net area at the root of the threads is less
- ii. Under vibratory loads, the strength is reduced if the connections get loosened
- iii. Unfinished bolts have lesser strength because of non-uniform diameter
- iv. Architectural look

CLASSIFICATION OF BOLT

CLASSIFICATION ON BASIS OF MATERIAL AND STRENGTH

Ordinary structural bolt and high strength steel bolt.

BY TYPE OF SHANK :

Unfinished or black bolt,

Turned bolt and

High strength friction grip bolt (HSFG).

High strength friction grip bolt is generally use in case of high load and if we need less number of hole, less number of bolt then we have to go for HSFG bolt.

PITCH AND FIT OF THREAD

Standard pitch bolt,

Fine pitch bolt and

Coarse pitch bolt.

SHAPE OF HEAD AND NUT

Square bolt (HEAD IS SQUARE)or

Hexagonal bolt. (HEAD IS HEXAGONAL)

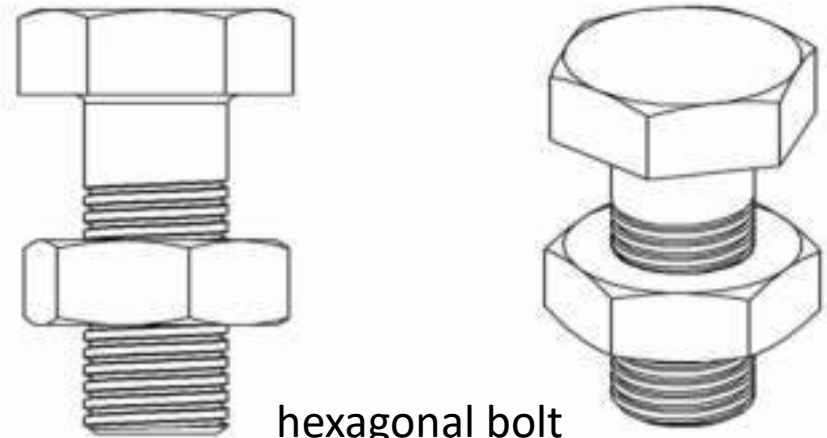

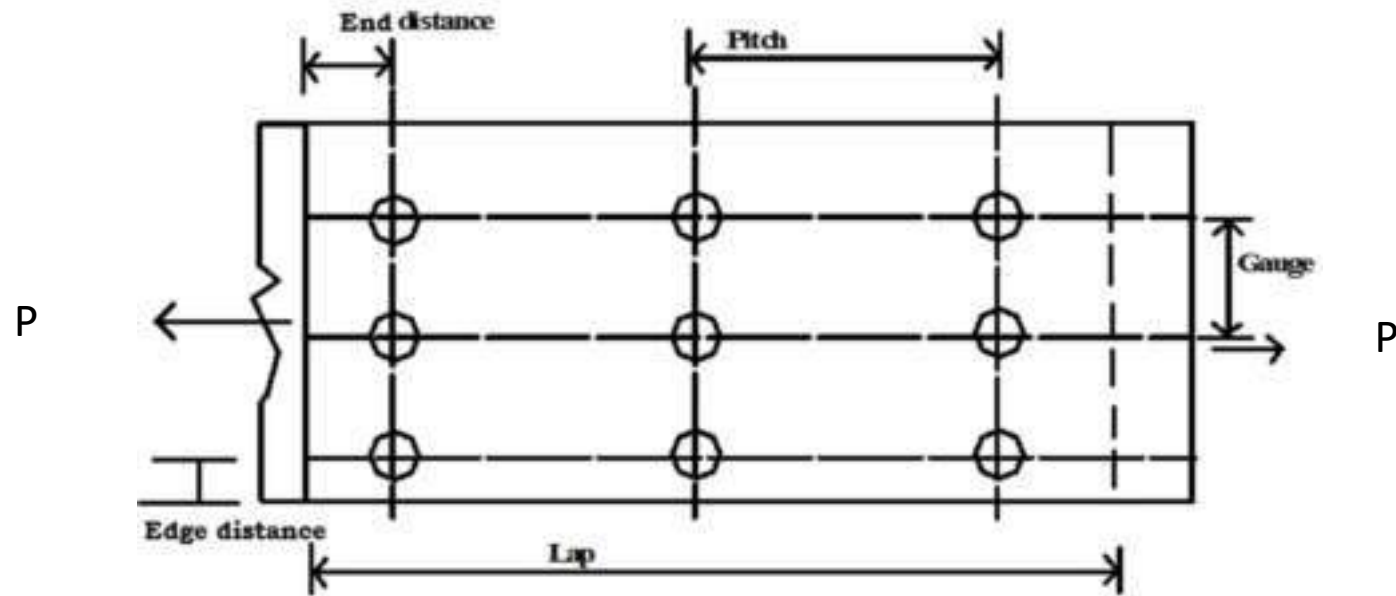

Pitch is the center to center distance of adjacent bolt measure in the direction of stress means the force direction.

The perpendicular to the direction of stress, the center to center distance of adjacent bolt is called gauge distance.

Parallel to the direction of stress, the distance from the center of outermost bolt to the edge of the plate is called end distance and

Perpendicular to the stress, the distance if we consider is called edge distance.

Minimum pitch distance is $2.5d$ or 2.5 times nominal diameter of the rivet or bolt. Minimum pitch is required to tighten the bolts properly and to prevent the bearing failure between two bolts if it is very closer.

MAXIMUM PITCH

- Maximum pitch is desirable to place bolt sufficiently close to reduce the length of connection and if different members connecting at a point, we have more pitch distance than the gusset plate will be require more. maximum pitch is defined in code which is written that the pitch should be $16t$ or 200 mm in tension and it should be less than $12t$ or 200 mm in compression. t = thickness of thinner plate
- Minimum edge distance for rivet that is given $1.5d$, where d is the nominal diameter of the rivet, rivet has nominal diameter is termed as small d and gross diameter which is the hole diameter actually in case of rivet that is termed as D and this D will be $d + 1.5$ for d is less than 25 mm and it will be $d + 2$ mm for d is greater than or equal to 25 mm, which is given in **IS 800: 1984 in the earlier code, in clause 3.6.1.1**

- For bolt, in case of bolt the minimum and maximum edge distance and end distance are given in clause 10.2.4.2 and 10.2.4.3. It is stated that the minimum edge or end distance that should be greater than 1.7 times the hole diameter (d_h) in case of sheared or hand-flame cut edges and it should be greater than 1.5 times the hole diameter in case of rolled, machine flame cut, sawn and planed edges.
- So for different cases the minimum edge distance is defined either 1.7 times the d_h or 1.5 times d_h and maximum edge distance, but it should be less than $12t\varepsilon$, where $\varepsilon = (250/f_y)^{1/2}$ and t is thickness of the thinner part.

Table 19 Clearances for Fastener Holes
(Clause 10.2.1)

Sl No.	Nominal Size of Fastener, d mm	Size of the Hole = Nominal Diameter of the Fastener + Clearances mm			
		Standard Clearance in Diameter and Width of Slot	Over Size Clearance in Diameter	Clearance in the Length of the Slot	
(1)	(2)	(3)	(4)	Short Slot (5)	Long Slot (6)
i)	12 – 14	1.0	3.0	4.0	$2.5 d$
ii)	16 – 22	2.0	4.0	6.0	$2.5 d$
iii)	24	2.0	6.0	8.0	$2.5 d$
iv)	Larger than 24	3.0	8.0	10.0	$2.5 d$

Slot Dimensioning

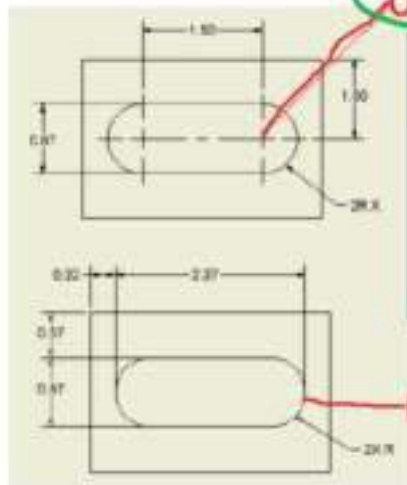

0.87x1.50

The two methods shown on the left are the acceptable methods for dimensioning slotted holes.

0.87x2.37



WIDTH/LENGTH

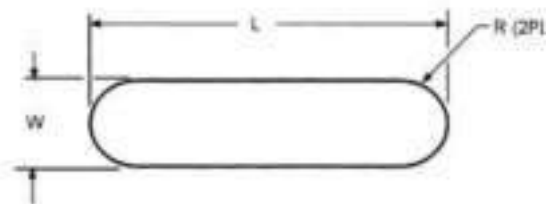
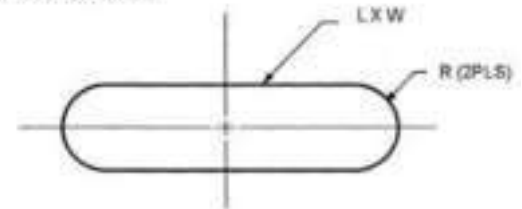

CENTER POINT

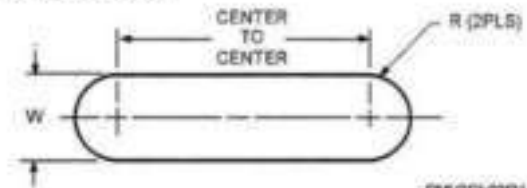

DMV/2CH/0301

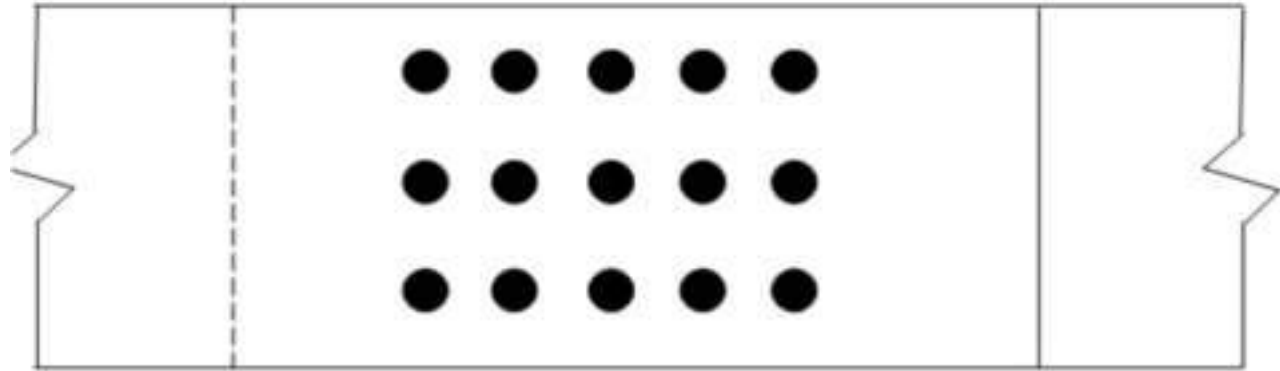

Chain bolting

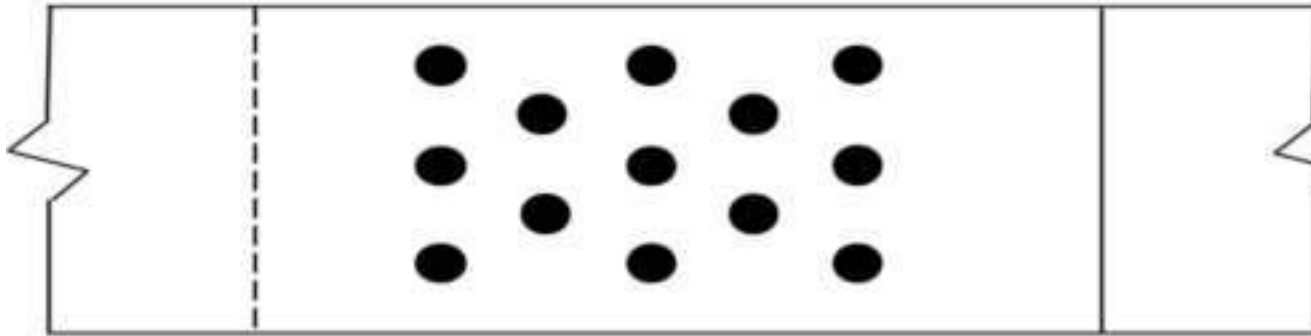

Zig-zag bolting

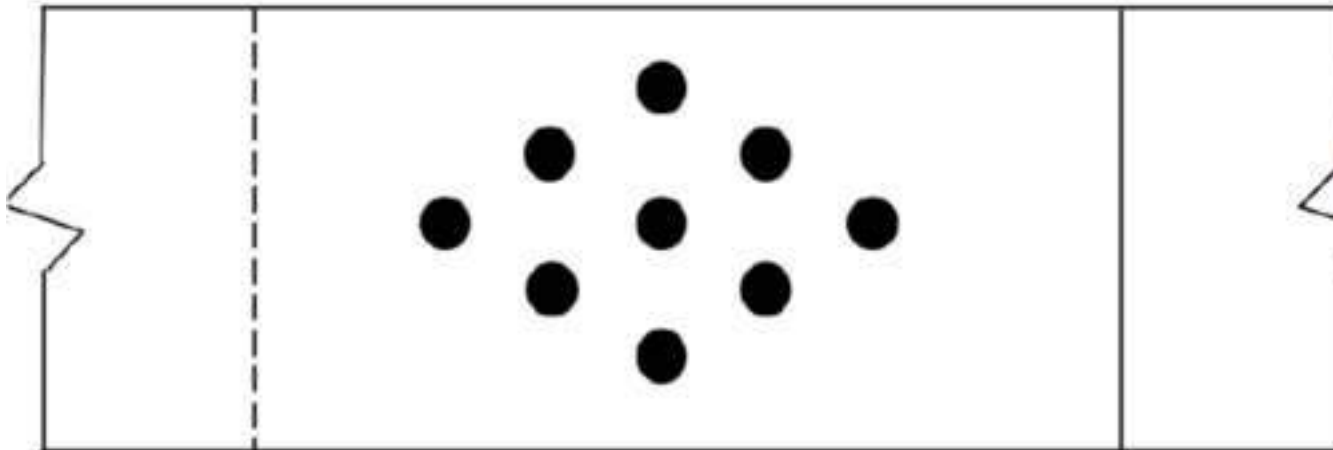

Diamond bolting

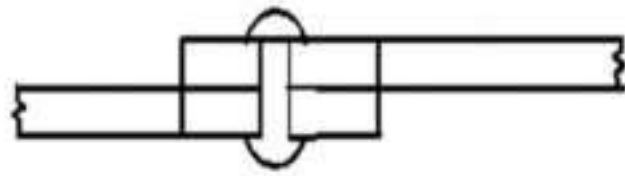

Single bolted lap joint

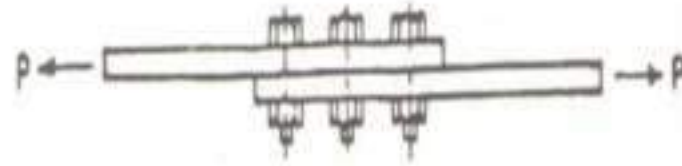

Triple bolted lap joint

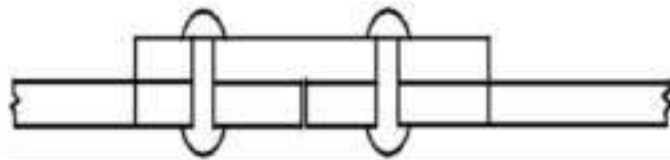

Single bolted single cover butt joint

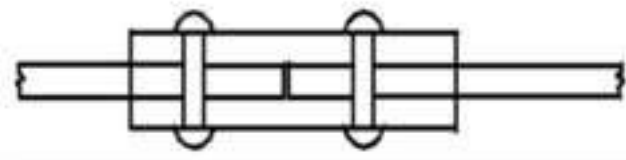

Single bolted double cover butt joint

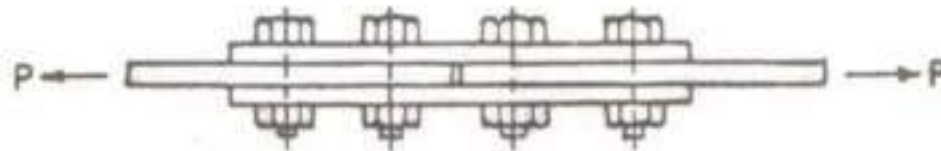

Double bolted double cover butt joint

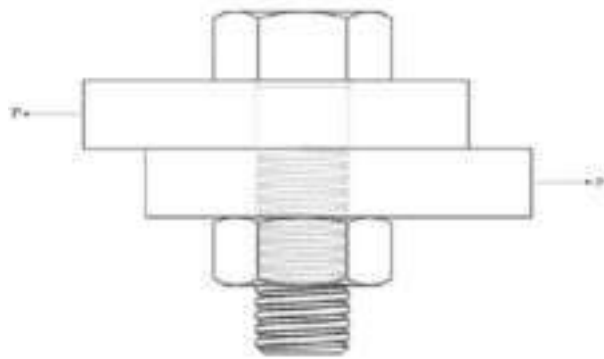

Single shear

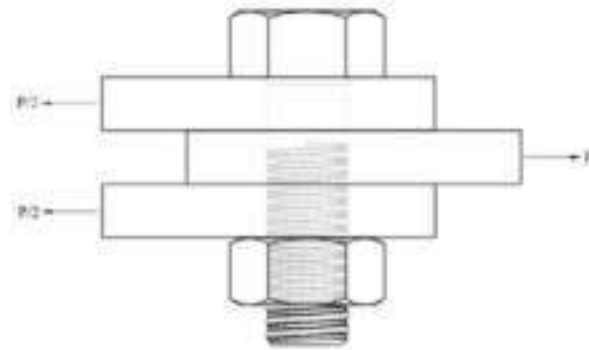

Double shear

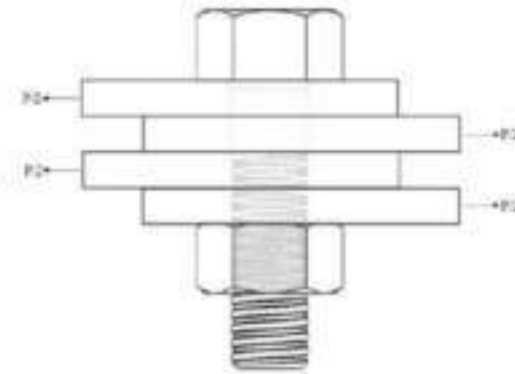

Multiple shear

Bolts with different shear

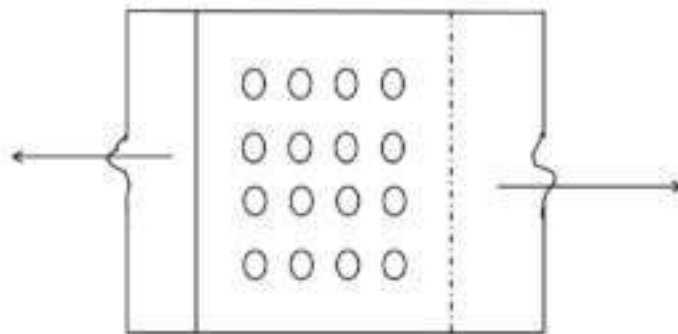

Direct shear connection

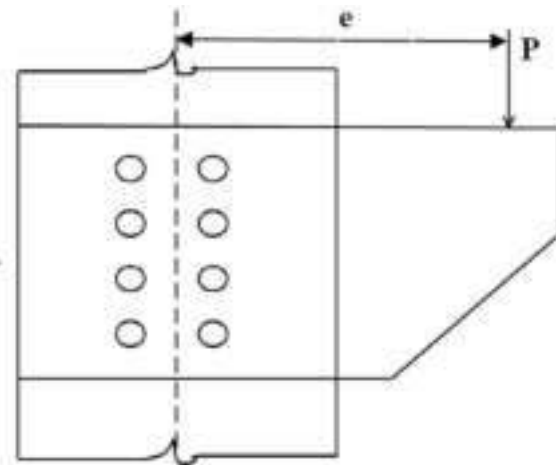

Eccentric connection

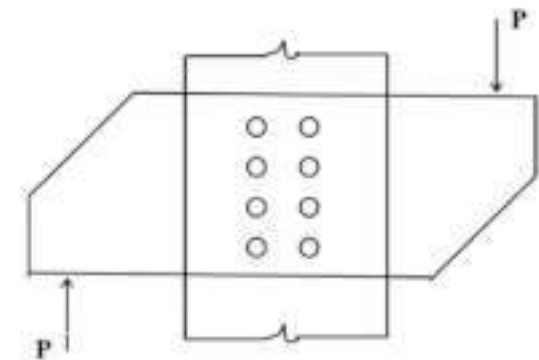

Pure moment connection

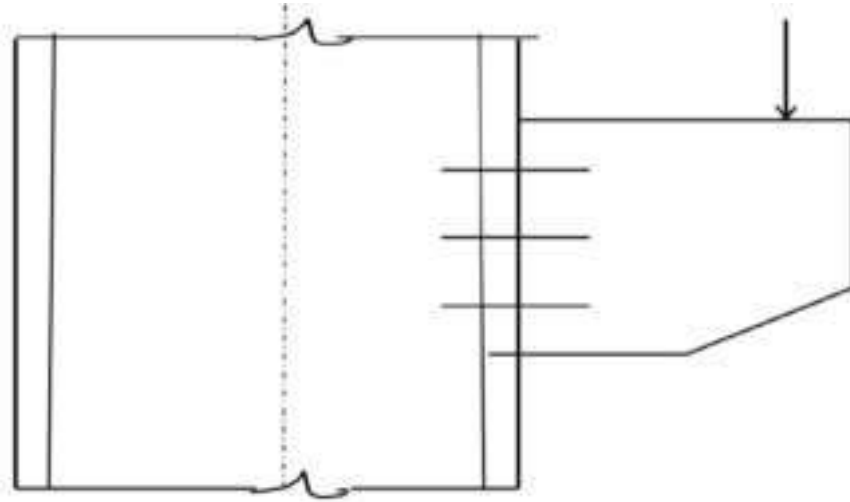

Moment shear connection

FAILURE MECHANISM

- AFTER DESIGN, THE FAILURE MAY BE FAILURE OF BOLT OR PLATE

The bolted joint may fail in any of the following seven ways, out of which some failure can be checked by adherence to the specifications of edge distance. Therefore, they are not of much importance, whereas the others require due consideration.

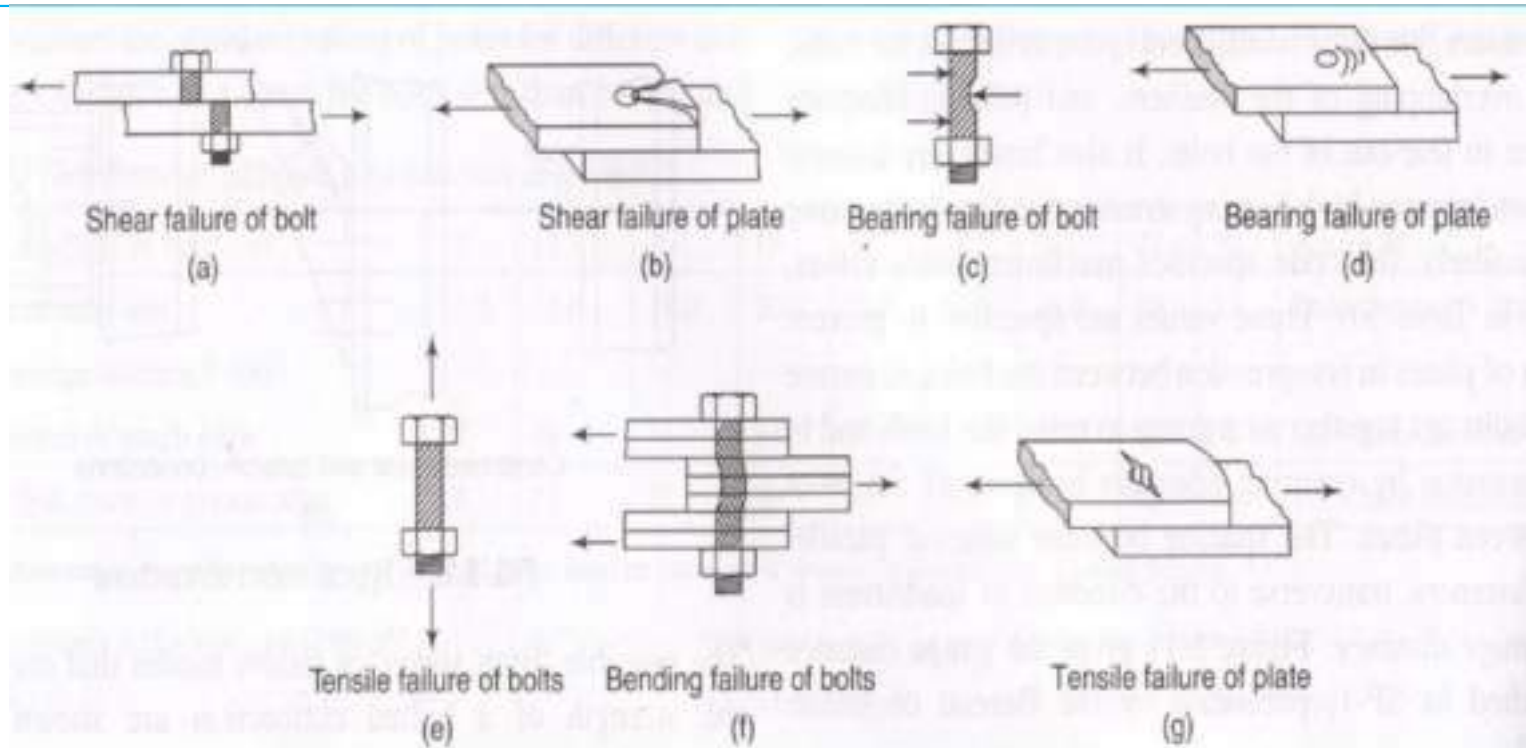

Possible modes of failure of bolted connections

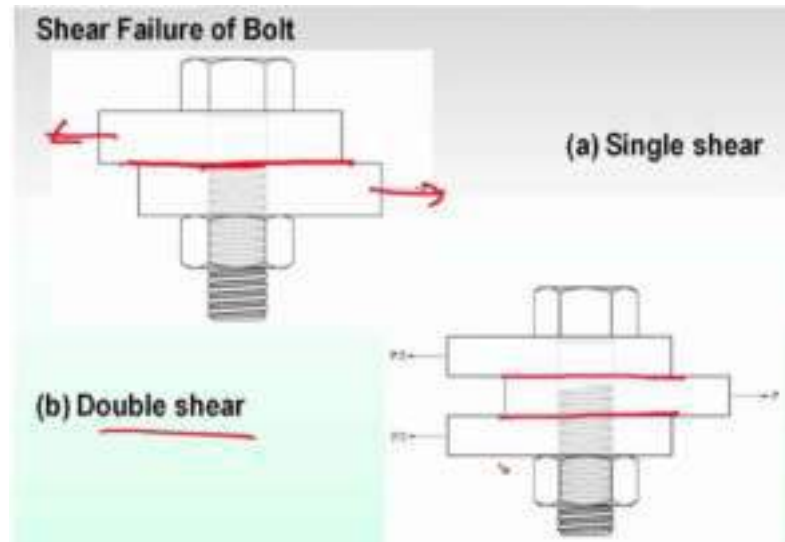

In single shear only one shear plane is developed in the shank portion of the bolt wherein double shear two shear plane are developed in the bolt.

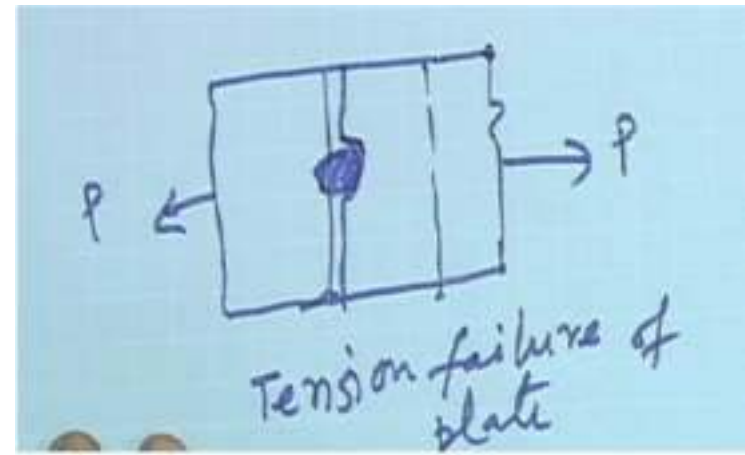
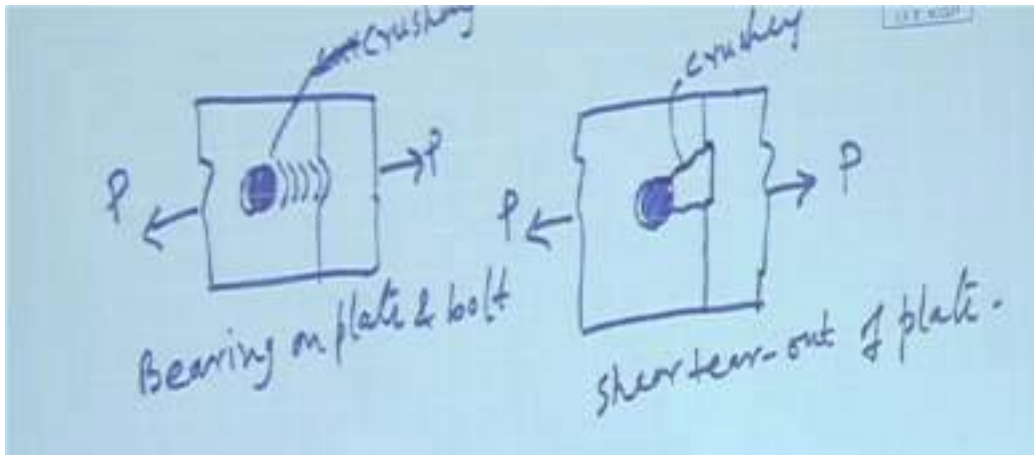

if two plates are connected with bolt then due to bearing on plate it may fail that means it may fail by crushing as shown in the above figure. So this is one type of failure which is called bearing failure.

SHEAR TEAR-OUT OF PLANE that means failure by crushing due to shear tear-out of plate. So such type of failure may occur when force P is in the direction as shown in the figure.

TENSION FAILURE of plate may be due to tension of plates, crack may be along that hole line and tension failure of plate may happen.

Another failure, due to shearing of two plates may tear out as shown in the figure due to failure of plate.

BLOCK SHEAR FAILURE

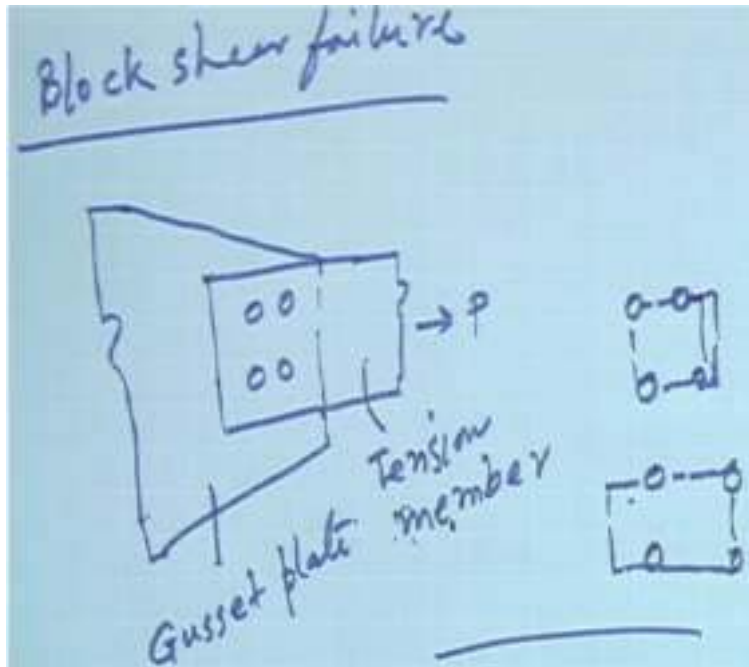

When a plate is connected with another plate or with a gusset plate and a force P is acting and if bolts are inserted as shown in the figure then the block shear failure may occur as a hole.

IMPORTANT THINGS

1. The stress concentration results in a considerable decrement in the tensile strength so we have to try to avoid the stress concentration.
2. Then loose fit of the joint can reduce the stiffness which may result in excessive deflections. So that has to be taken care that means we have to tighten the bolts properly so that the loose fit does not occur and joint does not get reduced instantly.
3. Vibration cause loosening of nuts which can jeopardize the safety of the structure.

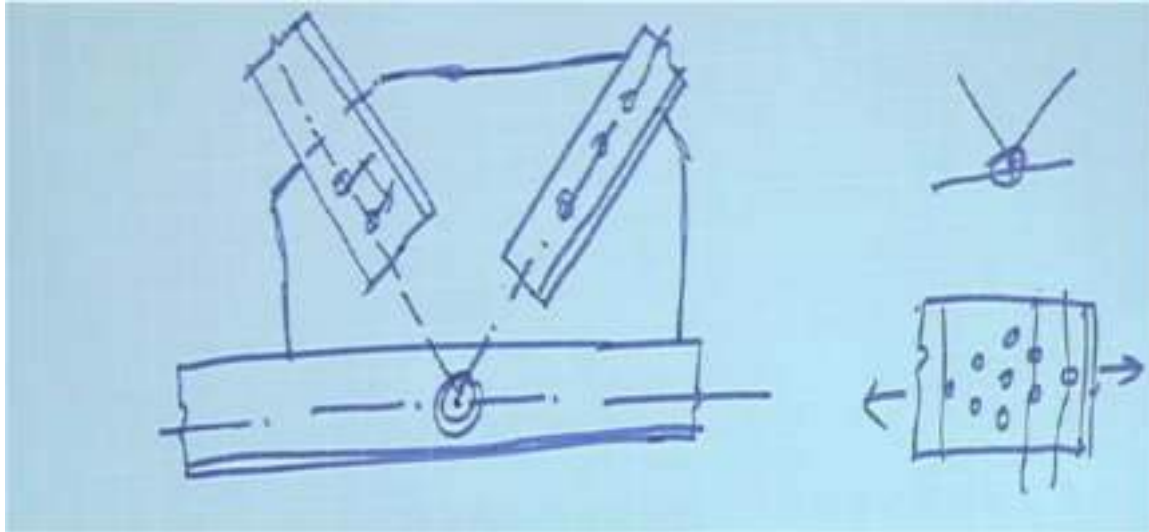

When a gusset plate connected with truss member as shown in the above Figure, different type of joints is possible as shown in Figure.

1. Join in such way that cg of each members pass through a particular point otherwise eccentricity may develop then the moment due to eccentricity may come into picture.
2. The length of joint should be as less as possible to reduce the material amount. If more number of bolts are provided , reduction in length may not be possible.
3. Another thing is that the center line of all members meeting at a joint should coincide at one point only otherwise the joint will twist out of position. The number of bolts should be increased gradually towards the joint for uniform stress distribution in bolt. For this type of connection, we prefer diamond bolting where the number of bolts increased towards the center.

SELECTIONS OF TYPE OF CONNECTION

- Riveted connections were once very popular and are still used in some cases but will gradually be replaced by bolted connections. This is due to the low strength of rivets, higher installation costs and the inherent inefficiency of the connection. Welded connections have the advantage that no holes need to be drilled in the member and consequently have higher efficiencies. However, welding in the field may be difficult, costly, and time consuming. Welded connections are also susceptible to failure by cracking under repeated cyclic loads due to fatigue which may be due to working loads such as trains passing over a bridge (high-cycle fatigue) or earthquakes (low-cycle fatigue). A special type of bolted connection using High Strength Friction Grip (HSFG) bolts has been found to perform better under such conditions than the conventional black bolts used to resist predominantly static loading.
- Bolted connections are also easy to inspect and replace. The choice of using a particular type of connection is entirely that of the designer and he should take his decision based on a good understanding of the connection behaviour, economy and speed of construction. Ease of fabrication and erection should be considered in the design of connections. Attention should be paid to clearances necessary for field erection, tolerances, tightening of fasteners, welding procedures, subsequent inspection, surface treatment and maintenance.

TYPES OF BOLTS

- There are several type of bolts
- Unfinished or Black bolts or C grade bolts-(IS 1363 :2002)
- Turned Bolts a) Precision bolts or A grade bolts(IS 1364: 2002)
b) Semi Precision Bolts or B grade bolts (IS 3640: 1982,
IS 1364: 2002)
- Ribbed Bolts
- High Strength Bolts (IS 3757: 1985 and IS 4000:1992)

TYPES OF BOLT CONNECTION

- UNFINISHED/BLACK/BEARING TYPE BOLT;

Black bolts are unfinished and are made of mild steel and are usually of Grade 4.6. Black bolts have adequate strength and ductility when used properly; but while tightening the nut snug tight ("Snug tight" is defined as the tightness that exists when all plies in a joint are in firm contact) will twist off easily if tightened too much. The International Standards Organisation designation for bolts, also followed in India, is given by Grade x.y. In this nomenclature, x indicates one-hundredth of the minimum ultimate tensile strength of the bolt in N/mm^2 and the second number, y, indicates the ratio of the yield stress to ultimate stress. for example, grade 4.6 bolt will have a minimum ultimate strength 400 (400 MPa) and minimum yield strength of 0.6 times 400, which is 260 MPa.

Square heads cost less, hexagonal heads look better.

Bolt designated as M16,M20 with dia of shank.

Hole dia 1.5 mm to 2 mm more than bolt size.

When the nuts are tightened with wrenches, little tension is produced, hence no clamping force is induced in in the joint

These are known as bearing type bolts also.

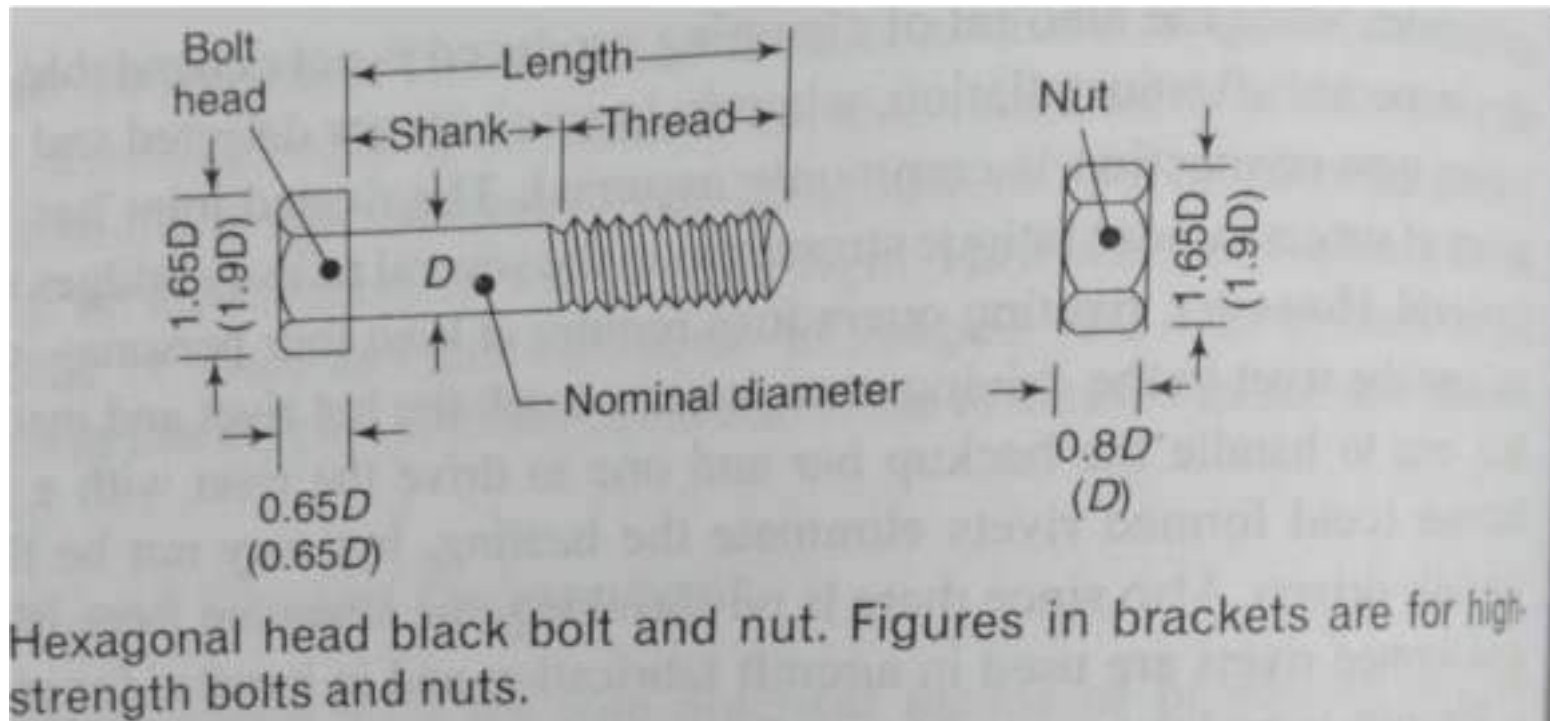

Table 5.1 Tensile properties of fasteners used in steel construction

Specification	Grade/ classification	Properties		
		Yield stress, MPa (Min)	Ultimate tensile stress, MPa (Min)	Elongation percent- age (Min)
IS 1367 (Part 3) (ISO 898) Specifications of fasteners-threaded steel for technical supply conditions	3.6	180	330	25
	4.6	240	400	22
	4.8	320	420	14
	5.6	300	500	20
	5.8	400	520	10
	6.8	480	600	8
	8.8 ($d < 16$ mm)	640	800	12
	9.8	720	900	10
IS 7557 Specification for steel wire (up to 20 mm) for the manufacture of cold forged rivets	10.9	940	1040	9
	12.9	1100	1220	8
	Annealed condition	160	330–410	30
	As-drawn condition	190	410–490	20

Table 5.2 Dimensions of hexagon head black bolts (grade 4.6) as per IS 1364 (Part 1)

Bolt size (<i>d</i>), mm	Head diagonal (<i>e</i>), mm	Head thickness (<i>k</i>), mm	Thread* length (<i>b</i>), mm	Pitch of thread, mm	Washer (IS 5370)		
					Outer diameter, mm	Inner diameter, mm	Thickness, mm
(12)	20.88	8	20	1.75	24	14	3
16	26.17	10	23	2.0	30	18	3
20	32.95	13	26	2.5	37	22	3
(22)	35.03	14	28	2.5	39	24	3
24	39.55	15	30	3.0	44	26	4
(27)	45.20	17	33	3.0	50	30	4
30	50.85	19	35	3.5	56	33	4
36	60.79	23	40	4.0	66	39	5

*For length $l \leq 125$ mm. For $125 < l \leq 200$, b is 6 mm more and for $l > 200$, b is 19 mm more. Sizes in brackets not preferred.

Turned and fitted bolts

These are similar to unfinished bolts with difference that shanks of these bolts are formed from hexagonal rod.

Turned and fitted bolts have uniform shanks and are inserted in close tolerance drilled holes and made snug tight by box spanners. The diameter of the hole is about 1.5 to 2.0 mm larger than the bolt diameter for ease in fitting. High strength black bolts (grade 8.8) may also be used in connections in which the bolts are tightened snug fit. In these bearing type of connections, the plates are in firm contact but may slip under loading until the hole surface bears against the bolt. The load transmitted from plate to bolt is therefore by bearing and the bolt is in shear. Under dynamic loads, the nuts are liable to become loose and so these bolts are not allowed for use under such loading. In situations where small slips can cause significant effects as in beam splices, black bolts are not preferred. However, due to the lower cost of the bolt and its installation, black bolts are quite popular in simple structures subjected to static loading. Turned and fitted bolts are available from grade 4.6 to grade 8.8. For the higher grades there is no definite yield point and so 0.2% proof stress is used.

High Strength Friction Grip bolts (HSFG)

provide extremely efficient connections and perform well under fluctuating/fatigue load conditions. These bolts should be tightened to their proof loads and require hardened washers to distribute the load under the bolt heads. The washers are usually tapered when used on rolled steel sections. The tension in the bolt ensures that no slip takes place under working conditions and so the load transmission from plate to the bolt is through friction and not by bearing. However, under ultimate load, the friction may be overcome leading to a slip and so bearing will govern the design. HSFG bolts are made from quenched and tempered alloy steels with grades from 8.8 to 10.9. The most common are the so-called, general grade of 8.8 and have medium carbon content, which makes them less ductile. The 10.9 grade have a much higher tensile strength, but lower ductility and the margin between the 0.2% yield strength and the ultimate strength is also lower. The tightening of HSFG bolts can be done by either of the following methods (IS 4000):

Turn-of-nut tightening method: In this method the bolts are first made snug tight and then turned by specific amounts (usually either half or three-fourth turns) to induce tension equal to the proof load below Fig.

Calibrated wrench tightening method: In this method the bolts are tightened by a wrench Fig.b calibrated to produce the required tension.

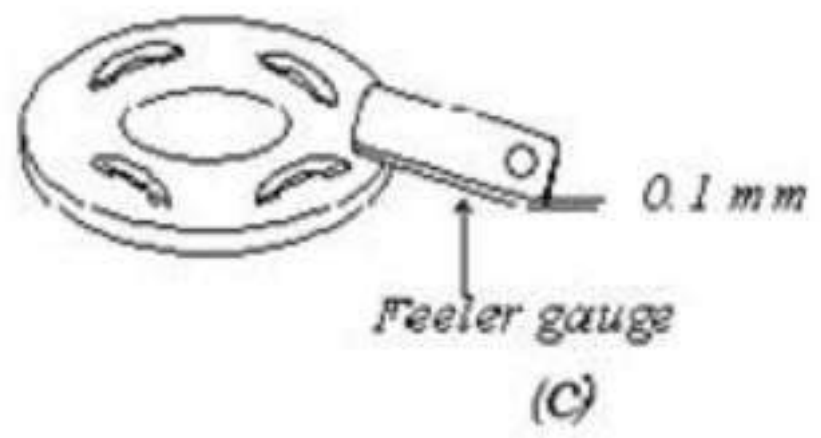
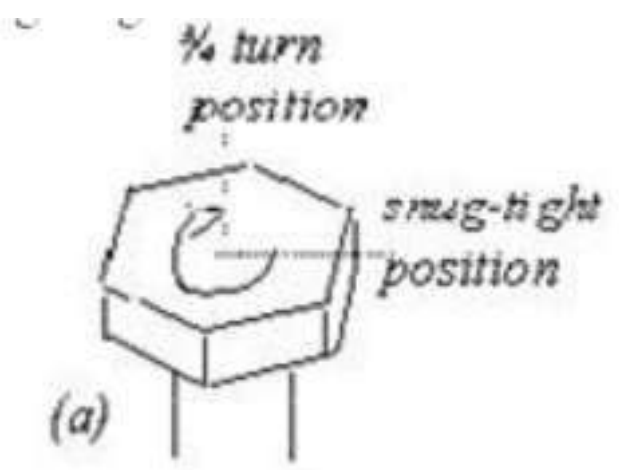
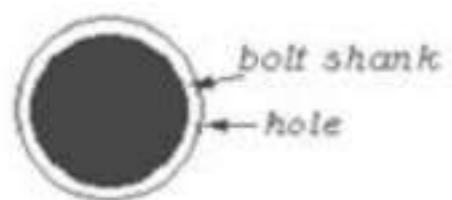

Photo of Wrench
(b)

High Strength Friction Grip bolts (HSFG)

Direct tension indicator method: In this method special washers with protrusions are used. As the bolt is tightened, these protrusions are compressed and the gap produced by them gets reduced in proportion to the load. This gap is measured by means of a feeler gauge, consisting of small bits of steel plates of varying thickness, which can be inserted into the gap.

Since HSFG bolts under working loads, do not rely on resistance from bearing, holes larger than usual can be provided to ease erection and take care of lack-of-fit. Typical hole types that can be used are standard, extra large and short or long slotted. These are shown in Figure 8. However the type of hole will govern the strength of the connection. Holes must also satisfy pitch and edge/end distance criteria (Cl.10.2 of IS 800:2007). A minimum pitch is usually specified for accommodating the spanner and to limit adverse interaction between the bearing stresses on neighbouring bolts. A maximum pitch criterion takes care of buckling of the plies under compressive loads



(a) Standard

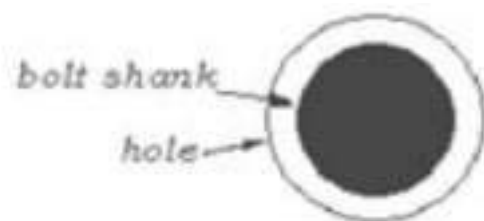

(b) Oversized

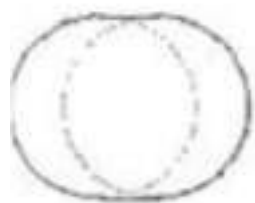

(c) Short Slot



(d) Long slot

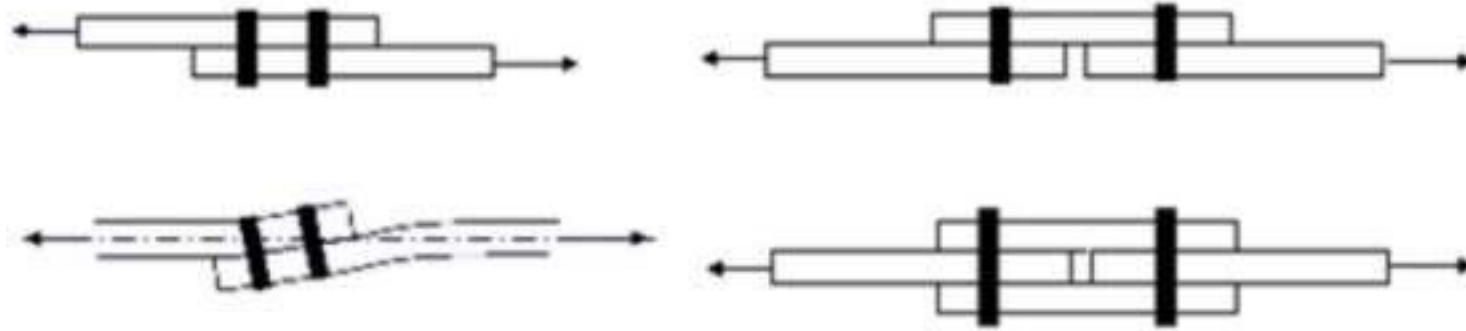

(a) Lap Connection

(b) Butt Connection

FAILURE OF BLACK BOLT

Failure

1. SHEARING STRENGTH OF BOLTS
2. BEARING STRENGTH OF BOLTS
3. TENSILE STRENGTH OF BOLTS
4. TENSILE STRENGTH OF PLATE
5. COMBINED SHEAR AND TENSION

$$V_{nsb} = \frac{f_{ub}}{\sqrt{3}} (n_n A_{nb} + n_s A_{sb}) \beta_{lj} \beta_{lg} \beta_{pkg}$$

Where, V_{nsb} = nominal capacity of bolts in shear

f_{ub} = ultimate tensile strength of bolts

n_n = no. of shear planes with threads intercepting the plane

n_s = no. of shear planes without threads intercepting the plane

β_{lj} = reduction factor which allows for overloading of end bolts that occur in long connections

β_{lg} = reduction factor for large grip lengths

β_{pkg} = reduction factor for packing plates thicker than 6mm

A_{nb} = net tensile area of bolt to be considered at the root of the threads = $0.78 \times \pi \times d^2 / 4$

A_{sb} = nominal plain shank area of the bolt

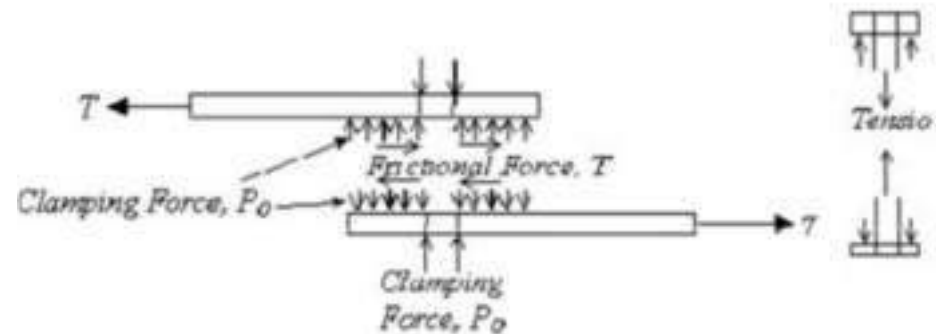

REDUCTION FACTORS

β_{lj} which is the reduction factor due to long joint. So long joint means if the length of joint become more than 15 times of nominal diameter of the bolt is consider as long joint and the reduction factor β_{lj} can be calculated as follows:

$$\beta_{lj} = 1.075 - \frac{l_j}{(200d)} \text{ but } 0.75 < \beta_{lj} < 1.0$$

Where, l_j is length of the joint

β_{lg} which is reduction factor due to large grip length which is consider if the grip length, l_g is more than $5d$, where d is the nominal diameter of the bolt.

$$\beta_{lg} = \frac{8d}{(3 + l_g)}$$

Packing factor is β_{pkg} which can be calculate as follows

If thickness of packing plates $t_{pkg} > 6\text{mm}$, then $\beta_{pkg} = 1 - 0.0125t_{pkg}$

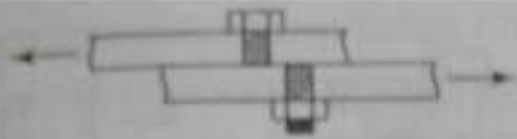

Shear failure of bolt
(a)



Shear failure of plate
(b)

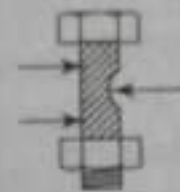

Bearing failure of bolt
(c)



Bearing failure of plate
(d)



Tensile failure of bolts
(e)

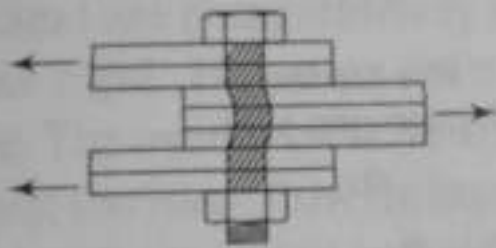

Bending failure of bolts
(f)

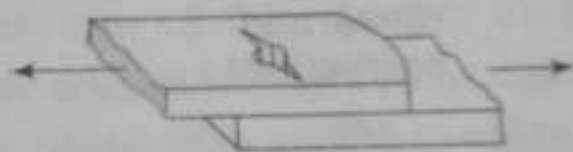

Tensile failure of plate
(g)

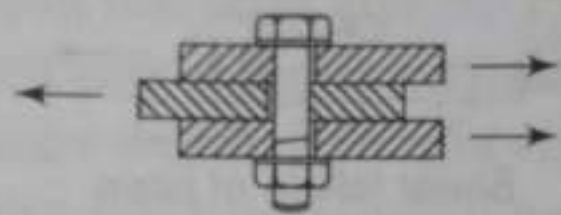

Bolt forces

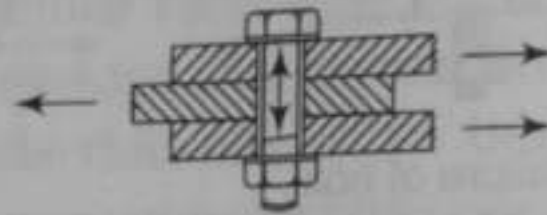
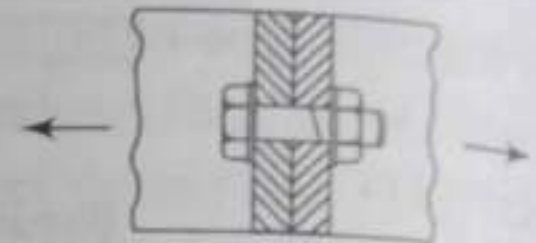
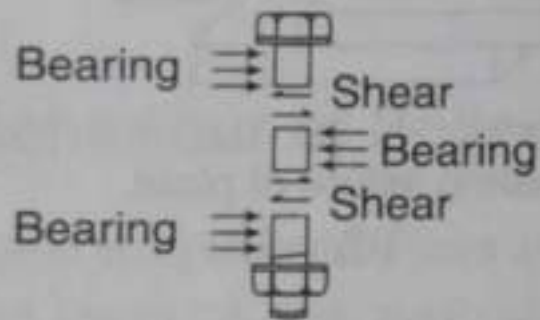

Plate forces



Bolt forces



Shear and bearing joint

(a)

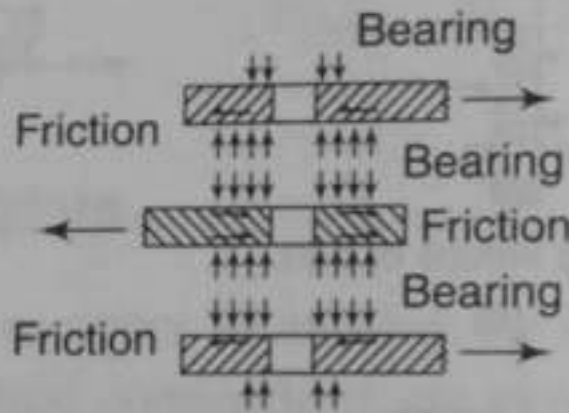

Pre-loaded friction-grip joint

(b)



Tension joint

(c)

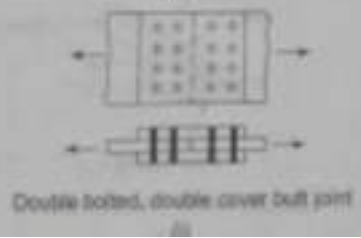
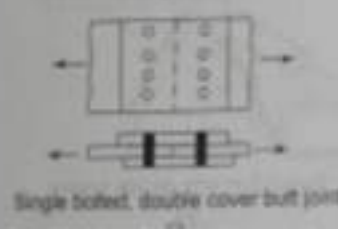
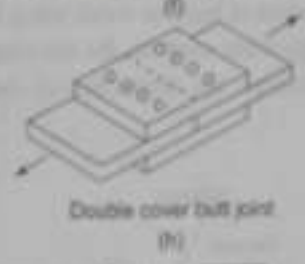
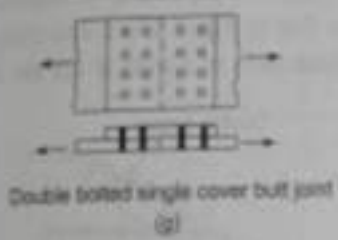
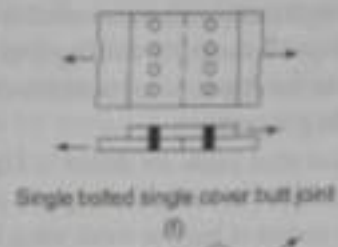
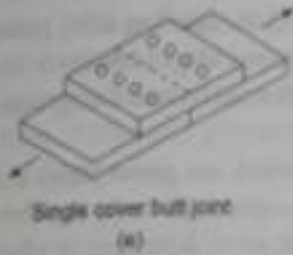
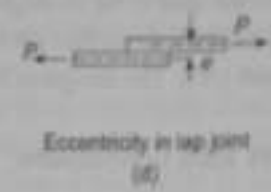
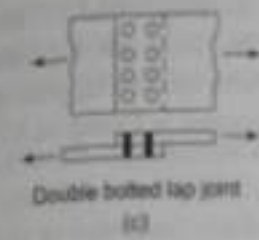
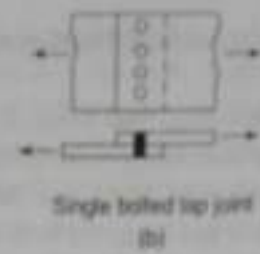
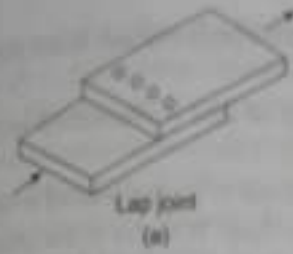

A_{ns} is the cross sectional area of the plane shank of the bolt = $\pi d^2/4$, d is the nominal diameter of the bolt

A_{nb} is the cross sectional area of the threaded portion of the bolt. net area of the threaded portion we will reduce to a certain extent which is suggested by the code as 0.78 times the cross sectional area of the shank area, that means this will be reduced to $0.78 \times \pi d^2/4$.

$$V_{dsb} = \frac{V_{dsb}}{\gamma_{mb}}$$

Where V_{dsb} = Design shear force

γ_{mb} = Partial safety factor for bolted connection

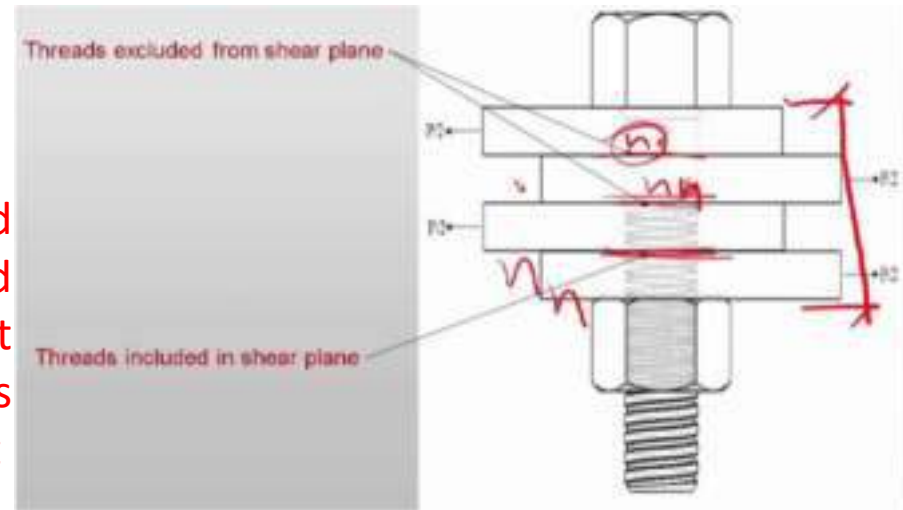

BEARING FAILURE OF BOLTS

- Nominal bearing strength of bolt:

$$V_{npb} = 2.5 * k_b * d * t * f_u$$

$$k_b = \text{smaller of } \frac{e}{3d_0}, \frac{p}{3d_0} - 0.25, \frac{f_{ub}}{f_u}, 1.0$$

Earlier formulae ultimate stress of bolt is used, but here it is ultimate tensile strength of plate because it is bearing on plate.

f_u = ultimate tensile stress of plate

f_{ub} = ultimate tensile stress of bolt

d = nominal diameter of bolt

d_0 = diameter of hole

t = summation of thickness of connected plates experiencing bearing stress in same direction

- Design shear force = $V_{dpb} = V_{npb} / \gamma_{mb}$,
- γ_{mb} Partial safety factor for bearing

STRENGTH OF BOLT IN TENSION

- Strength in Tension

$$[T_{nb} = (0.9 * f_{ub} * A_{nb})] < f_{yb} A_{sb} * \frac{\gamma_{m1}}{\gamma_{m0}}$$

T_{nb} = nominal capacity of a bolt in tension

f_{ub} = ultimate tensile stress of bolts

A_n = net tensile stress area

A_{sb} = shank area of bolt

f_{yb} = yield stress of bolt

γ_{m0} = partial safety factor for material resistance governed by yielding = 1.1
(table 5 of IS: 800)

γ_{m1} = partial safety factor for material resistance governed by ultimate stress =
1.25 (table 5 of IS: 800)

Design tensile force = $T_{db} = T_{nb} / \gamma_{mb}$ and γ_{mb} is basically 1.25.

TENSILE STRENGTH OF PLATE

The plate may fail by tension also, before failure of bolt.

$$T_{nd} = \frac{0.9 f_u A_n}{\gamma_{m1}}$$

- Where, T_{nd} = tension capacity of plate
- f_u = ultimate tensile stress of plate
- A_n = Net effective area of plate
- γ_{m1} = partial safety factor = 1.25

The net effective area of plate is calculated from the following formula:

- $A_n = (b - nd_0) t$
- Where, b = width of plate
- n = number of holes along width perpendicular to the direction of load
- d_0 = hole diameter = nominal diameter of bolt + clearance of the hole
- t = thickness of plate

PROBLEM

Calculate the shear strength of 16 mm diameter bolt of grade 4.6. The bolt is under triple shear as shown in the figure below.

$$V_{nsb} = \frac{f_{ub}}{\sqrt{3}} (n_n A_{nb} + n_s A_{sb}) b_{lj} b_{lg} b_{pkg}$$

n_n = no. of shear planes with threads intercepting the plane = **1**

n_s = no. of shear planes without threads intercepting the plane = **2**

Nominal diameter of bolt, $d = 16 \text{ mm}$

Diameter of hole, $d_o = 18 \text{ mm}$

For grade 4.6 bolts; $f_{ub} = 400 \text{ MPa}$

For Fe 410 grade of steel; $f_u = 410 \text{ MPa}$

For 16 mm diameter bolt;

Net shear area of bolt at threads is $A_{nb} = 0.78 * (\pi/4) * d^2 = 157 \text{ mm}^2$

Net shear area of bolt at shank is $A_{ns} = (\pi/4) * d^2 = 201 \text{ mm}^2$

$$V_{nsb} = \frac{400}{\sqrt{3}} (1 * 157 + 2 * 201) 1 * 1 * 1$$

$$V_{dsb} = \frac{V_{nsb}}{\gamma_{m1}} = 103 \text{ kN}$$

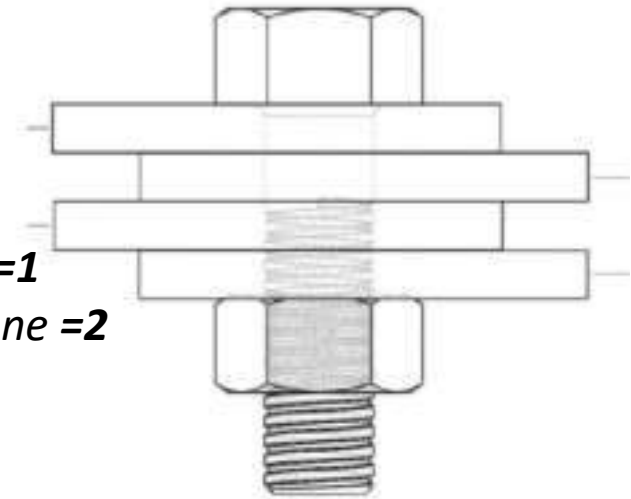

PROBLEM-2

Design the following joints using ordinary black bolts between two plates of width 200 mm and thicknesses 10 mm and 18 mm respectively to transmit a factored load of 150 kN. Use plates made of Fe 410 grade steel and 16 mm diameter bolt of grade 4.6.

SOLUTION:

Nominal diameter of bolt, $d = 16 \text{ mm}$

Diameter of hole, $d_o = 18 \text{ mm}$ (Ref. Table 19 of IS 800: 2007)

For grade 4.6 bolts; $f_{ub} = 400 \text{ MPa}$

For Fe 410 grade of steel; $f_u = 410 \text{ MPa}$

Partial safety factor for bolt, $\gamma_{mb} = 1.25$

A) LAP JOINT without reduction factor

Here $n_n=1$, $n_s=0$ $A_n=157 \text{ mm}^2$

$$V_{nsb} = \frac{f_{ub}}{\sqrt{3}} (n_n A_{nb} + n_s A_{sb}) b_{lj} b_{lg} b_{pkg}$$

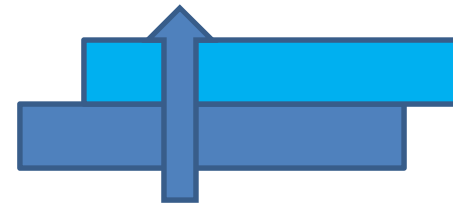

- DESIGN STRENGTH OF BOLT IN SHEAR

$$V_{dsb} = \frac{400}{1.25 * \sqrt{3}} (1 * 157 + 0 * 201) 1 * 1 * 1 = 29 \text{ kN}$$

- No. of bolts required=150/29=5.2 say 6 Bolts
- Design bearing strength per bolt,

$$V_{dpb} = 2.5 * k_b * d * t * f_u / \gamma_{m1}$$

$$k_b = \text{smaller of } \frac{e}{3d_0}, \frac{p}{3d_0} - 0.25, \frac{f_{ub}}{f_u}, 1.0$$

$$k_b = \text{smaller of } \frac{31}{3 * 18}, \frac{50}{3 * 18} - 0.25, \frac{400}{410}, 1.0$$

$$V_{dpb} = 2.5 * 0.57 * 16 * 10 * \frac{410}{1.25} = 74.78 \text{ kN}$$

- As the strength of bolt is less in shear, take the design strength of bolt in shear

DESIGN FOR TENSION OF BOLT

$$[T_{nb} = (0.9 * f_{ub} * A_{nb}) < f_{yb} A_{sb} * \frac{\gamma_{m1}}{\gamma_{mo}}$$

$$T_{nb} = \{0.9 * 400 * 157 = (56.52 \text{ kN})\}$$

$$< \left[\left(240 * 201 * \frac{1.25}{1.1} \right) = 54.81 \text{ kN} \right]$$

$$T_{nd} = \frac{T_{nb}}{\gamma_{mb}} = \frac{54.81}{1.25} = 43.85 \text{ kN}$$

So, strength of bolt is minimum in shear. Provide 6 bolts

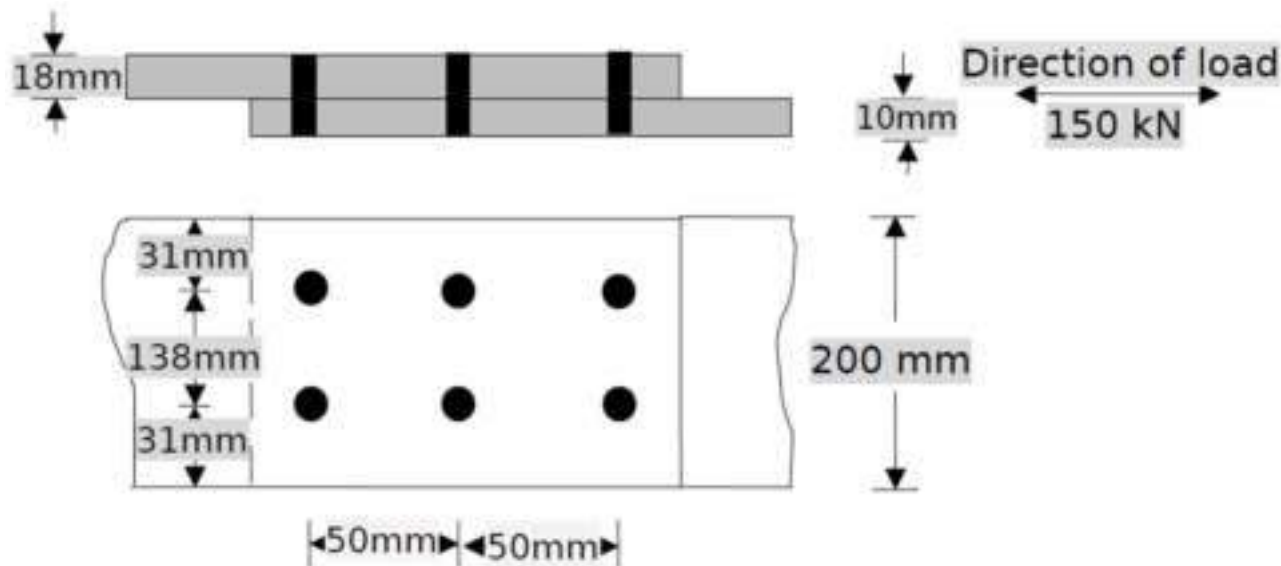

B) SINGLE COVER BUTT JOINT WITH COVER PLATE OF 8 MM.

- SINGE COVER BUTT JOINT

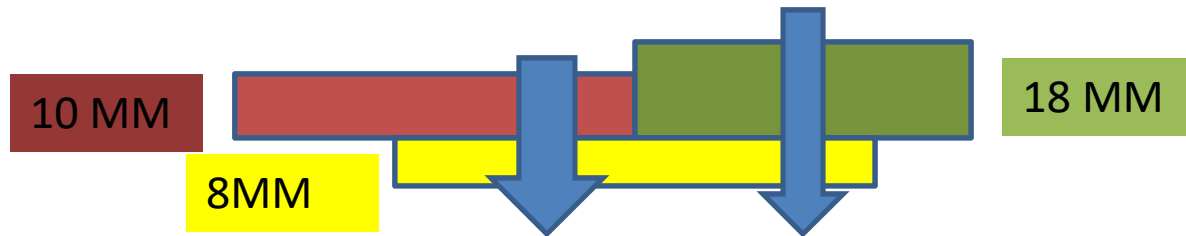

- Strength in Shear

$$V_{dsb} = \frac{400}{1.25 * \sqrt{3}} (1 * 157 + 0 * 201) 1 * 1 * 1 = 29 \text{ kN}$$

- Strength of Plate in bearing $V_{dpb} = 2.5 * k_b * d * t * f_u / \gamma_{m1}$

$$V_{dpb} = 2.5 * 0.57 * 16 * 8 * \frac{410}{1.25} = 59.83 \text{ kN}$$

- Provide 6 bolts

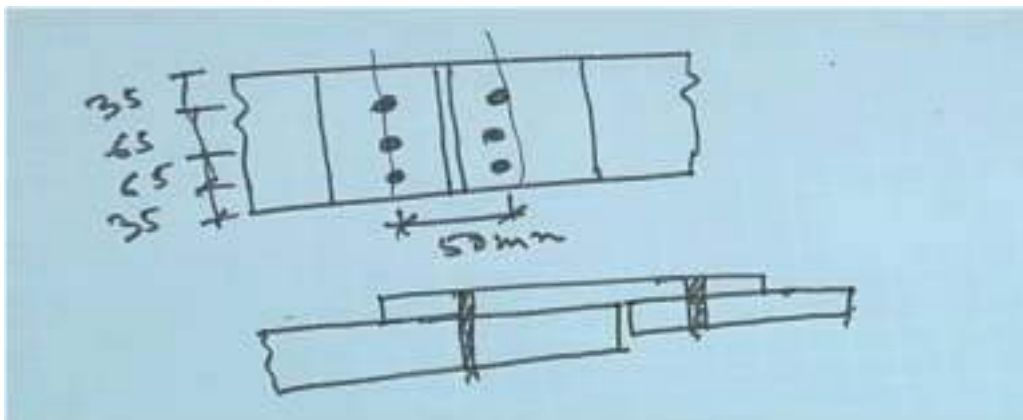

C) DOUBLE COVER BUTT JOINT WITH 8 MM COVERS PLATES:

- DOUBLE COVER BUTT JOINT WITH 8 MM COVER PLATE

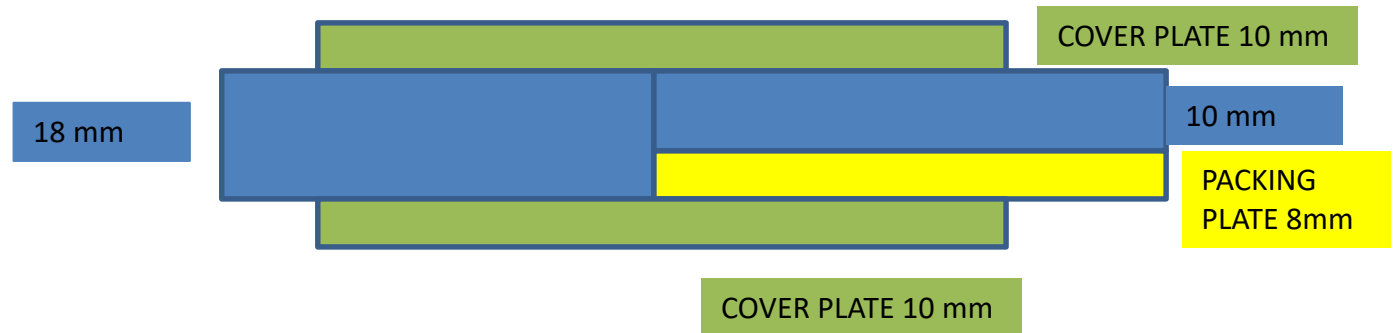

- As there is packing plate 8 mm > 6 mm, use reduction factor for packing.

- $\beta_{pkg} = (1 - 0.0125t_{pkg}) = (1 - 0.0125 * 8) = 0.9$

$$V_{nsb} = \frac{f_{ub}}{\sqrt{3}} (n_n A_{nb} + n_s A_{sb}) b_{lj} b_{lg} b_{pkg}$$

- Here $n_n = 2, n_s = 0$

$$V_{dsb} = \frac{400}{1.25 * \sqrt{3}} (2 * 157 + 0 * 201) 1 * 1 * 0.9$$

$$= 52.21 \text{ kN}$$

- **STRENGTH OF BOLT IN BEARING**

$$\begin{aligned} \text{Bearing strength per bolt} &= V_{dpb} \\ &= 2.5 * k_b * d * t * f_u / \gamma_{mb} \end{aligned}$$

- **d=16 mm, t=10 mm, p=65 mm, e=31 mm**

$$\begin{aligned} \text{Bearing strength per bolt} &= V_{dpb} \\ &= 2.5 * 0.57 * 16 * 10 * \frac{410}{1.25} = 74.78 \text{ kN} \end{aligned}$$

- **Strength of bolt=52.21 kN**
- **Provide 150/52.21= 3 nos.of bolts**

Two plates 10 mm thick are joined by 16mm diameter bolts in a triple staggered lap joint as shown in the figure. Find efficiency of the joint.

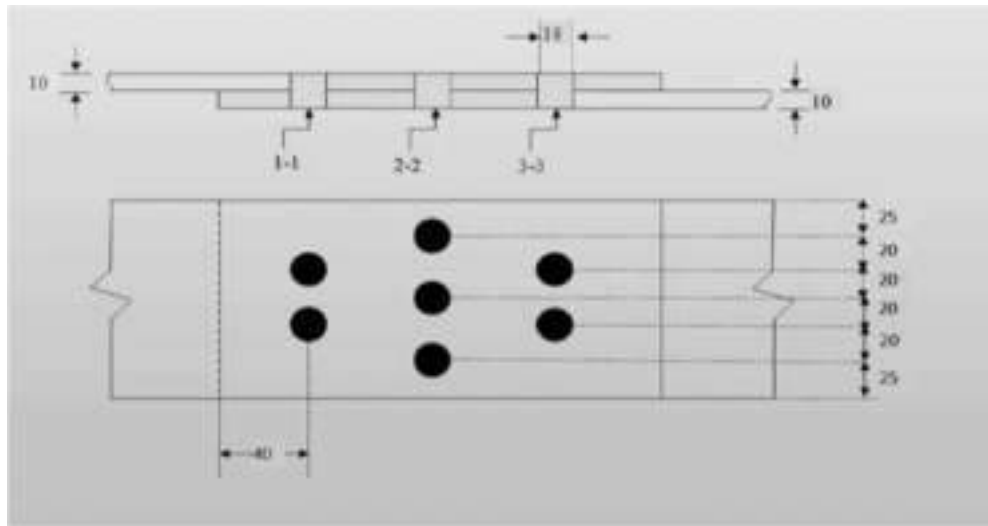

This is a triple staggered lap joint. The bolt lines are marked as 1-1, 2-2, 3-3. Now the failure may occur in any direction as marked in the above figure. So if we make section 1-1, 2-2, 3-3 then we have to consider first failure at 1-1 that we will try to find out then it will be going to fail in section 2-2. So when we are going to find out the strength at 2-2 that means we have to find out strength at bolt at 1-1 failure strength plus 2-2. So it will be clear when we will be going through this example.

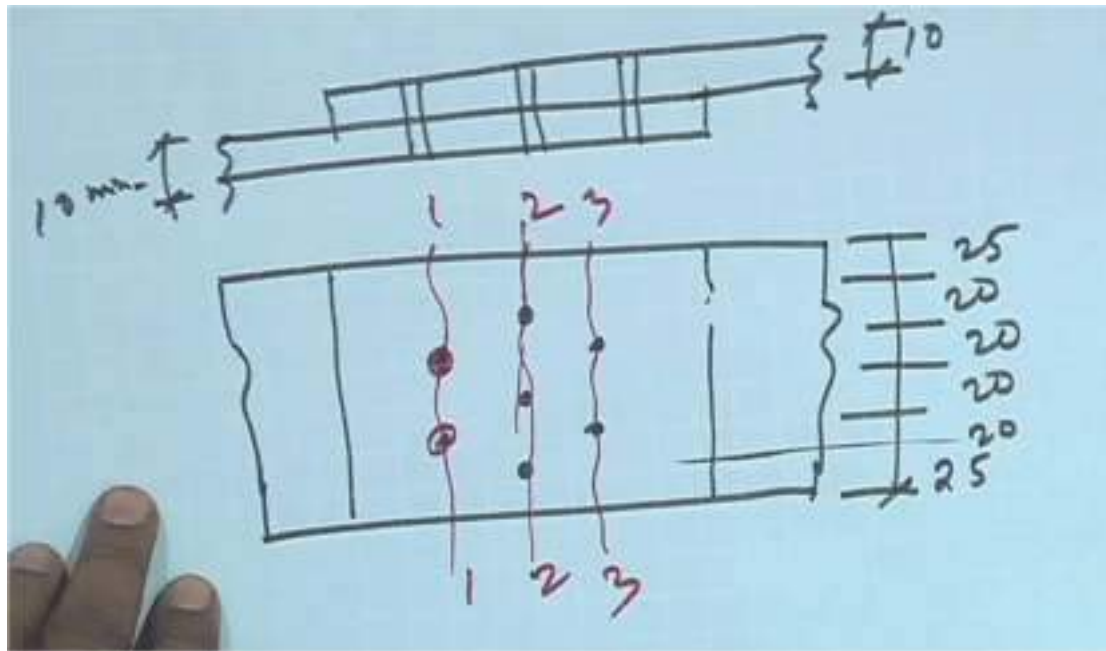

So if we draw the figure we will see this is a triple staggered lap joint. So bolt we can provide in this way. The bolt lines are marked as 1-1, 2-2, 3-3.

Now the failure may occur in any direction as marked in the above figure. So if we make section 1-1, 2-2, 3-3 then we have to consider first failure at 1-1 that we will try to find out then it will be going to fail in section 2-2. So when we are going to find out the strength at 2-2 that means we have to find out strength at bolt at 1-1 failure strength plus 2-2. So it will be clear when we will be going through this example.

So first let us consider section 1-1 means along 1-1 if it fails how it looks. So there first we have to find out the this is in single shear so the P single shear if I write then due to single shear V_{dsb} will be same as earlier and this will be 29 kN which we have already calculated in earlier case of 16 mm diameter because this is a single shear and diameter is 16 mm diameter so 29 kN will be the single shear strength shear strength due to single shear

- Design Values $Bearing\ strength\ per\ bolt = V_{dpb}$
 $= 2.5 * k_b * d * t * f_u / \gamma_{mb}$

Here, $e = 25\text{ mm}$, $p = 40\text{mm}$

$k_b = 25 / (3 \times 18)$, $40 / (3 \times 18) - 0.25$, $400 / 410$, 1

$k_b = 0.46$

$$Bearing\ strength\ per\ bolt = V_{dpb}$$

$$= 2.5 * 0.46 * 16 * 10 * \frac{410}{1.25} = 60.35\text{ kN}$$

So bolt value due to shear it is coming 29 and due to bearing it is coming 60. So smaller of this two will be the bolt value, so we can consider the bolt value as 29 kN, right.

So the strength of joint based on bolt value will become how much strength of joint because 7 number of bolts are there so this will be $7 \times 29 = 203\text{ kN}$

Again now we will see if it fails along section 1-1 then what will be the strength of that joint.

$$\text{Strength of joint along 1-1} = 0.9 * f_u * (b - n * d_h) * t / \gamma_{m1} = 0.9 * 410 * (130 - 1 * 18) * 10 / 1.25 = 277.49\text{ kN}$$

- Strength of joint along 2-2 =

$$0.9 \cdot f_u (b - n \cdot d_h) \cdot t / \gamma_{m1} + 2 \cdot B_V = 0.9 \cdot 410 \cdot (130 - n \cdot d_h) \cdot t / \gamma_{m1} = 0.9 \cdot 410 \cdot (130 - 3 \cdot 18) \cdot 10 / 1.25 + 2 \cdot 29 = 282.35 \text{ kN}$$

- Strength of joint along 3-3 =

$$0.9 \cdot f_u (b - n \cdot d_h) \cdot t / \gamma_{m1} + 5 \cdot B_V = 0.9 \cdot 410 \cdot (130 - 2 \cdot 8) \cdot 10 / 1.25 = 0.9 \cdot 410 \cdot (130 - 2 \cdot 18) \cdot 10 / 1.25 + 5 \cdot 29 = 422.49 \text{ kN}$$

For Staggered Pitch

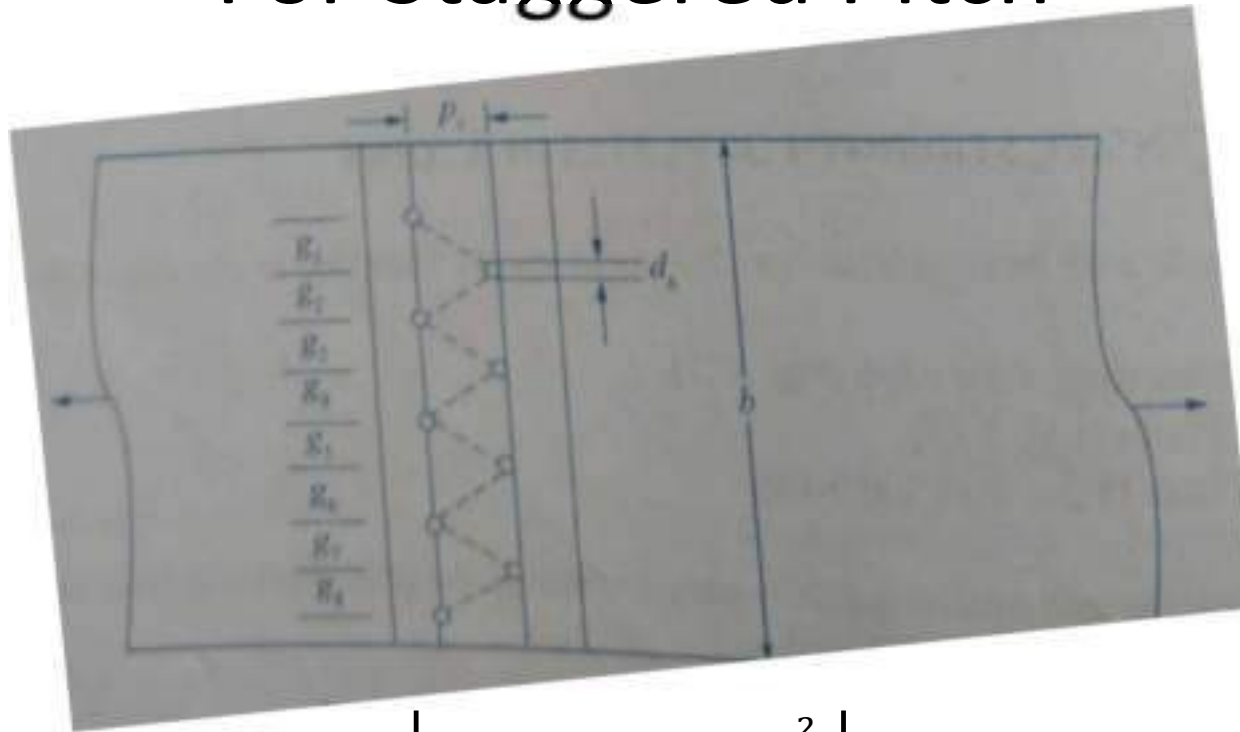

$$A_n = \left[b - n * d_0 + \sum \frac{p_{si}^2}{4g_i} \right] t$$

b= Width of the plate: t=Thickness of thinner plate

d_0 = Dia of hole: g= Gauge length between bolt holes

p_s =Staggered pitch length between lines of bolt holes

n= Number of bolt holes in the critical Section

i= Subscript for summation of all inclined legs

If no staggering then $A_n=(b-nd_0)t$

ECENTRIC CONNECTION WITH BEARING TYPE BOLTS

ECENTRIC CONNECTION(LOAD IS IN THE PLANE OF GROUP OF BOLTS)

The load will be in different position having some eccentricity. As there is eccentricity , moment will be created.

So therefore we have to design the joint taking consideration of the direct load as well as due to eccentricity.

different type of joint;

1. Line of action of eccentric load is in the plane of group of Bolts

2. Line of action of eccentric load is in the plane perpendicular to the plane of group of Bolts-when load is lying in the perpendicular to the plane of joint then another type of eccentricity come into picture means another type of load reaction will come.

LINE OF ACTION OF ECENTRIC LOAD IN THE PLANE OF BOLTS

If we draw the above figure we can see that a column is carrying some eccentric load which is coming from beam or say gusset plate. Now P is the load so the eccentricity will be e . So, the additional moment due to eccentricity will be $P \times e$. For each bolt, There will be direct shear load F_1 and load due to bending F_2 .

If n number of bolts are there, then load in each joint will be $F_1 = P/n$ assuming that the shear loads are distributed equally to each joint by .

$F_1 = P/n$ and this is the load which is coming due to direct load.

Now another load $F_2 = F_m =$ (Due to moment) will come because of moment $= P \cdot e$.

r is radial distance as shown in the above figure.

$F_2 \propto r$

$F_2 = Kr$ where K is proportionality constant.

Moment resisting capacity of any bolt $= F_2 \cdot r$

Moment resisting capacity of all bolt $= \sum F_2 \cdot r = \sum k \cdot r^2 = K \sum r^2$

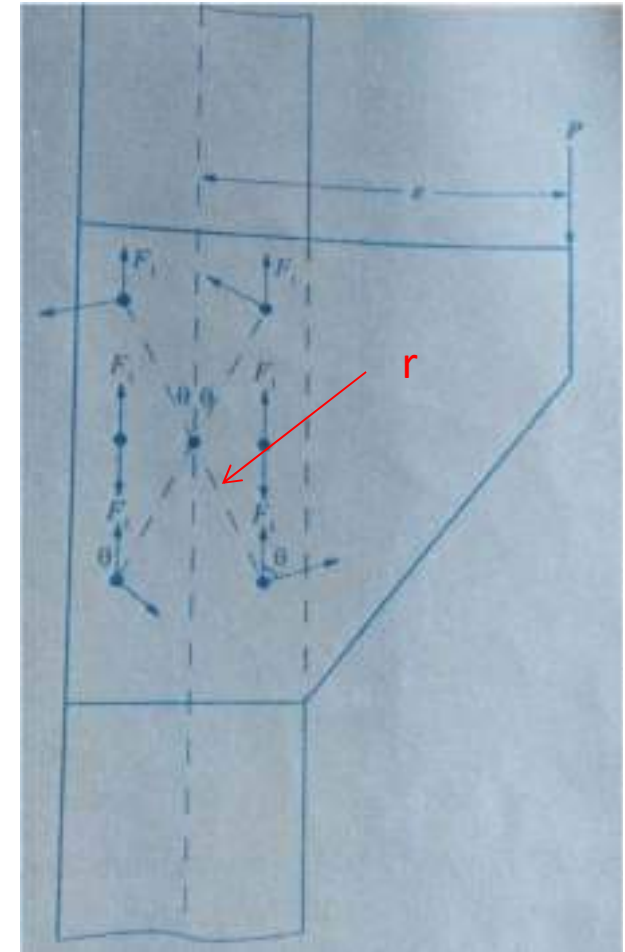

- Total Moment to be resisted= $M=P*e$
- So, $K \sum r^2 = M=P*e$
- $K=M / \sum r^2 = P*e / (\sum r^2)$
- $F_2=P*e*r / (\sum r^2)$
- Total Force on a bolt= Resultant of F_1+F_2

$$R = \sqrt{F_1^2 + F_2^2 + 2 * F_1 * F_2 * \cos \theta}$$

For Design Purpose no. of bolts approximately required

m =Number of Vertical Lines

P = Pitch of the bolts in vertical direction

$$n = \sqrt{\frac{6M}{m * p * V_{dsb}}}$$

A bracket plate bolted to a vertical column is loaded as shown in Fig. M20 bolts of grade 4.6 are used. Find the maximum factored load that can be taken safely

Solution:

$d=20$ mm

$d_0=20+2=22$ mm

Thickness of ISMC 300 = 7.6 mm

This is lap joint between bracket and ISMC, bolt will be in single shear.

Design strength of bolt in shear=

$$V_{nsb} = \frac{f_{ub}}{\sqrt{3}} (n_n A_{nb} + n_s A_{sb}) b_{lj} b_{lg} b_{pkg}$$

$$V_{nsb} = \frac{400}{\sqrt{3}} \left(1 * 0.78 * \left(\frac{\pi}{4} \right) 20^2 + 0 * A_{sb} \right) 1 * 1 * 1$$

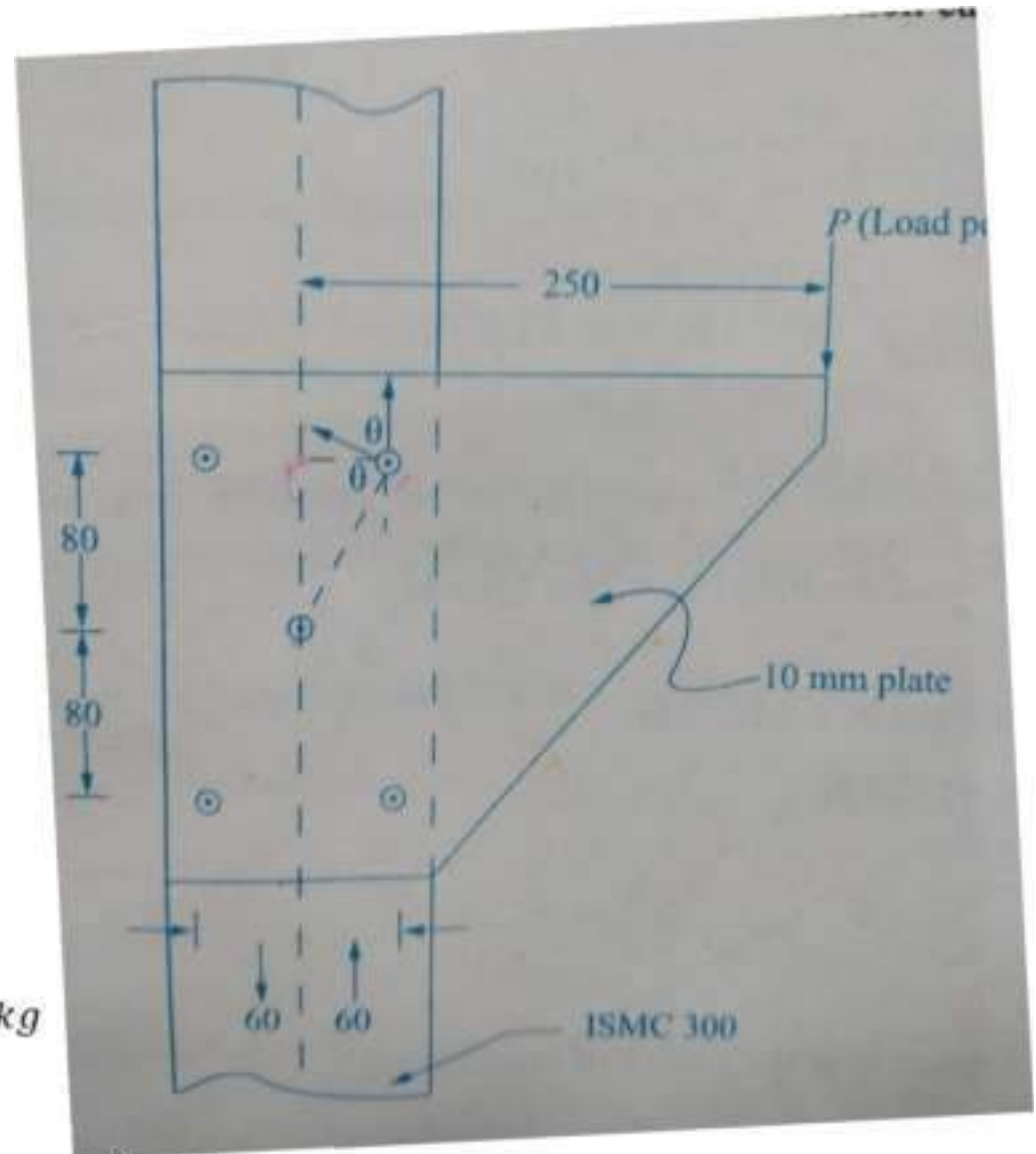

$$V_{dsb} = \frac{400}{1.25 * \sqrt{3}} \left(1 * 0.78 * \left(\frac{\pi}{4} \right) 20^2 + 0 * A_{sb} \right) 1 * 1$$

$$* 1 = 45.27 \text{ kN}$$

$$\text{Bearing strength per bolt} = V_{dpb}$$

$$= 2.5 * k_b * d * t * f_u / \gamma_{mb}$$

$$k_b = \text{smaller of } \frac{e}{3d_0}, \frac{p}{3d_0} - 0.25, \frac{f_{ub}}{f_u}, 1.0$$

$$e = 150 - 60 = 90,$$

$$p = 80 \text{ mm}$$

$$k_b = \text{smaller of } \frac{90}{3 * 22}, \frac{80}{3 * 22} - 0.25, \frac{400}{410}, 1.0$$

$$= 0.96212$$

$$\text{Bearing strength per bolt} = V_{dpb}$$

$$= 2.5 * 0.96212 * 20 * 7.6 * \frac{410}{1.25} = 119.91 \text{ kN}$$

- As strength in shear is less than bearing, take bolt strength in shear=45.27 kN
- If total load on bracket is P,
- Then $F_1 = P/5 = 0.2P$
- Centre of gravity of bolt will be at the centre of central bolt.
- $r=0$ for central bolt, r for other bolts= $\text{SQRT}(80^2+60^2)=100$ mm
- $\Sigma r^2 = 4 * 100^2 = 4 * 100 * 100 = 40000$ mm²
- Force on outer bolts= $F_2 = P * e * r / \Sigma r^2 = P * 250 * 100 / 40000 = 0.625 P$

$$R = \sqrt{F_1^2 + F_2^2 + 2 * F_1 * F_2 * \cos \theta}$$

R

$$= \sqrt{(0.2P)^2 + (0.625P)^2 + 2 * 0.2P * 0.625P * 60/100}$$

- $R = 0.76199P = 45.272$ kN
- $P = 59.413$ kN

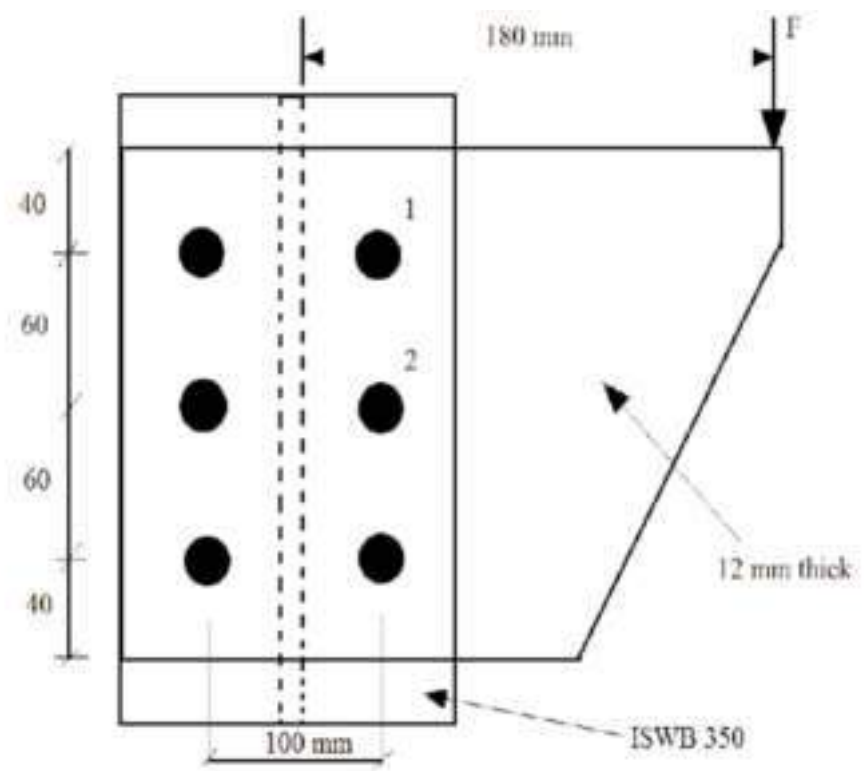

DESIGN OF BEARING BOLTS SUBJECTED TO ECENTRIC LOADING IN THE PLANE OF BOLTS

- If n is the number of bolts uniformly spaced at a distance p . The force in a bolt is proportional to its distance from the neutral axis. The maximum force in the extreme bolt should not exceed bolt strength.
- Average force per unit depth at extreme end $f' = V/p$
- Maximum force $f = f' * (n/n-1) = (V/p) * (n/n-1)$
- Total Force above the Neutral axis F
 $F = (1/2) * f * (np/2) = (1/2) * (V/p) * (n/n-1) * (np/2)$

Total force below the neutral axis is same as F and opposite in direction. These two forces form a couple to resist the moment.

$M = \text{Force} * \text{Lever arm}$

$$= F * [\text{Lever arm} = (2/3) * np]$$

$$= (1/2) * (V/p) * (n/n-1) * (np/2) * (2/3) * np = Vpn^3/6 * (n-1) = (Vpn^2/6) * n/n-1$$

$$n^2 = (6M/Vp) * (n-1)/n \cong (6M/Vp)$$

$$n = \sqrt{(6M/Vp)}$$

If there are two vertical lines, then a value of $2V$ is used in the formulae. N is the number of bolts in each line.

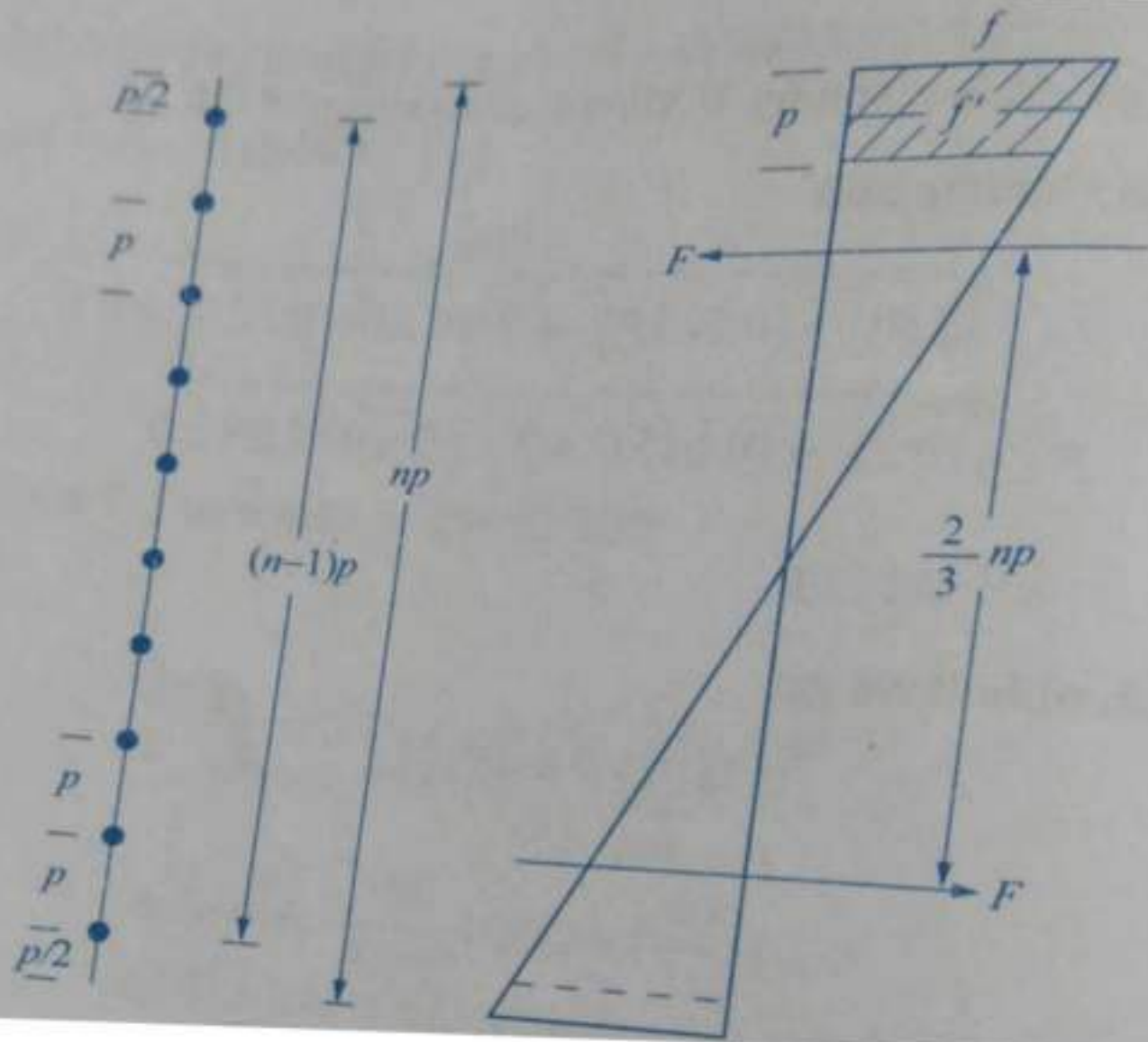

Design a bolted bracket connection to transfer an end reaction of 300 kN with an eccentricity of 170 mm, due to factored load as shown in the figure. The steel used is of grade FE 410. Use 20 mm diameter bolt of grade 4.6. The thickness of bracket plate is 10 mm and the column section is ISHB 200 @ 365.91 N/m.

For Fe 410 grade of steel: $f_u=410$ MPa

For bolts of grade 4.6: $f_{ub}=400$

Partial safety factor for the material of bolt:

$$\gamma_{m1}=1.25$$

For column section ISHB 200 @ 365.91 N/m,

Gauge, $g = 100$ mm

Thickness of flange, 9.0 mm

Diameter of bolt $d = 20$ mm

Diameter of hole $d_0 = 22$ mm [Table 19 IS 800]

Minimum edge distance, $e = 1.5 \times 22 = 33$ mm [cl. 10.2.4.2 –IS 800]

Net shear area of the bolt at threads,

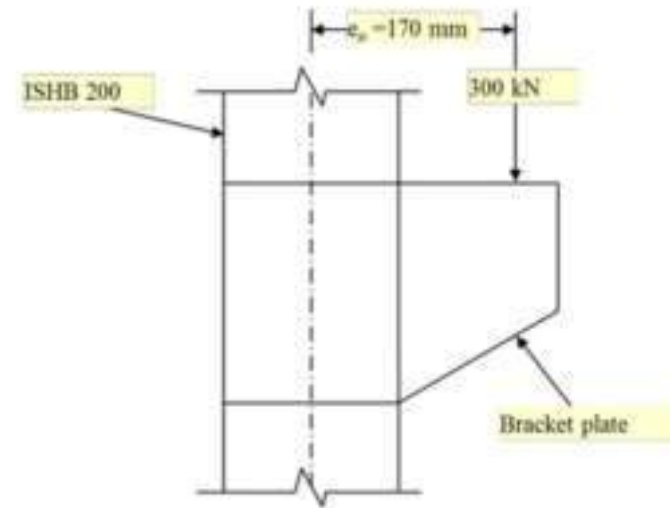

$$A_{nb} = 0.78 * \frac{\pi}{4} 20^2 = 245 \text{ mm}^2$$

Minimum pitch=2.5*20=50 mm

Minimum eccentricity=1.5*22=33 mm for rolled

Provide minimum pitch= 60 mm and e= 35 mm

$$V_{dsb} = \frac{400}{1.25 * \sqrt{3}} (1 * 245 + 0 * 314) 1 * 1 * 1 = 45.26 \text{ kN}$$

Strength of bolt in bearing,

$$V_{dpb} = \frac{2.5 * k_b * d * t * f_u}{\gamma_{mb}}$$

k_b is smaller of $35 / (3 * 22)$, $60 / (3 * 22) - 0.25$, $400 / 410$, 1

Hence, $k_b = 0.53$

$$V_{sd} = \frac{2.5 * 0.53 * 20 * 9 * 410 * 10^{-3}}{1.25} = 78.23 \text{ kN}$$

Hence, the strength of the bolt, $V_{sd} = 45.26 \text{ kN}$

Let us provide bolts in two vertical rows.

Moment due to eccentricity, $M = 170 \times 300 = 51000 \text{ kN-mm}$

number of row, $n' = 2$

Number of bolts required in one row,

$$n = \sqrt{\frac{6M}{pn'V_{ud}}} = \sqrt{\frac{6 \times 51000}{60 \times 2 \times 45.26}} = 7.51 \approx 8$$

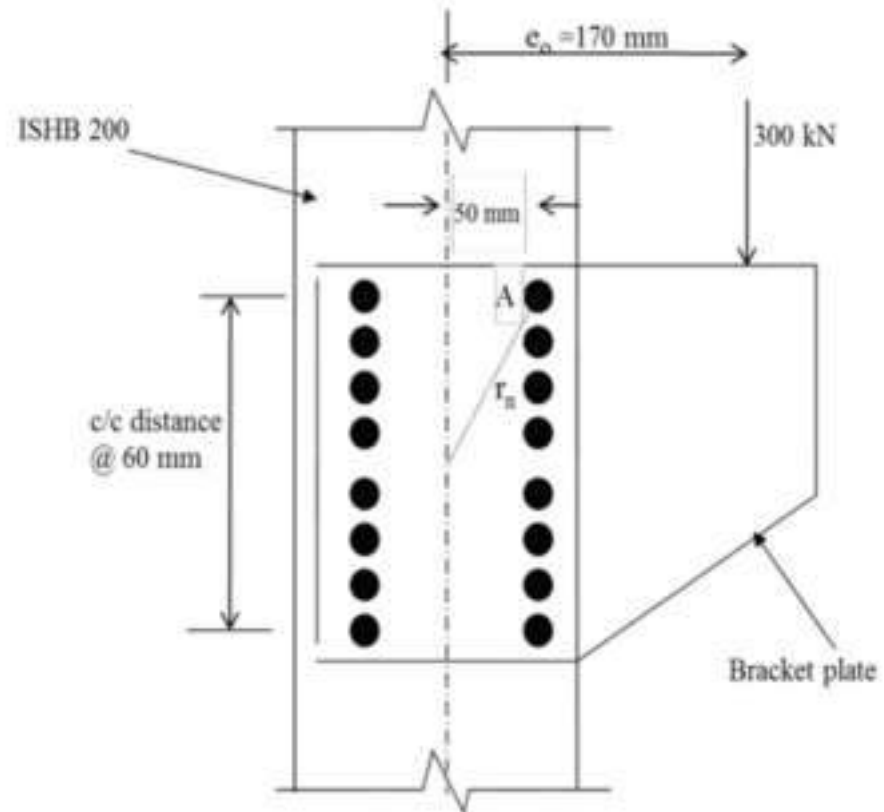

Force on critical bolt A

The direct force, $F_1 = \frac{P}{n} = \frac{300}{16} = 18.75kN$

The force in the bolt due to twisting moment, $F_2 = \frac{Pe_0 r_n}{\sum r^2}$

Eccentricity, $e_0 = 170$ mm

$$r_n = \sqrt{210^2 + 50^2} = 215.87mm$$

$$\begin{aligned}\sum r^2 &= 4 \times [(210^2 + 50^2) + (150^2 + 50^2) + (90^2 + 50^2) + (30^2 + 50^2)] \\ &= 342400mm^2\end{aligned}$$

$$F_2 = \frac{300 \times 170 \times 215.87}{342400} = 32.15kN$$

$$\cos \theta = \frac{50}{\sqrt{210^2 + 50^2}} = 0.232$$

Resultant force on the critical bolt,

$$F = \sqrt{F_1^2 + F_2^2 + 2F_1F_2 \cos \theta}$$

$$\begin{aligned}F &= \sqrt{18.75^2 + 32.15^2 + 2 \times 18.75 \times 32.15 \times 0.232} \\ &= 40.8kN < 45.26kN\end{aligned}$$

Hence, connection is safe.

LINE OF ACTION OF ECENTRIC LOAD IN THE PLANE PERPENDICULAR TO THE PLANE OF GROUP OF BOLTS

- DESIGN PARAMETERS:
- If there are n number of bolts, direct design shear force= $V_{sb}=F_1=P/n$
- Due to moment , tension will be in the upper side, on compression side total column and contact angle will resist the load.
- So, it is assumed CG will be at $h/7$ from bottom where h is depth of bracket.
- Tensile force on a bolt T_{bi} is proportional to its distance y_i .
- $T_{bi} \propto y_i$
- $T_{bi}=K*y_i$ $K=T_{bi}/y_i$
- Moment provided by a bolt= $T_{bi} * y_i = K*y_i * y_i = K*y_i^2$
- Total Moment provided by bolts= $\sum K*y_i^2$
- Total Moment provided by bolts= $M' = \sum K*y_i^2 = K\sum y_i^2$
- $K= M' / \sum y_i^2 = T_{bi}/y_i$
- $T_{bi}=K*y_i = (M' / \sum y_i^2)*y_i$

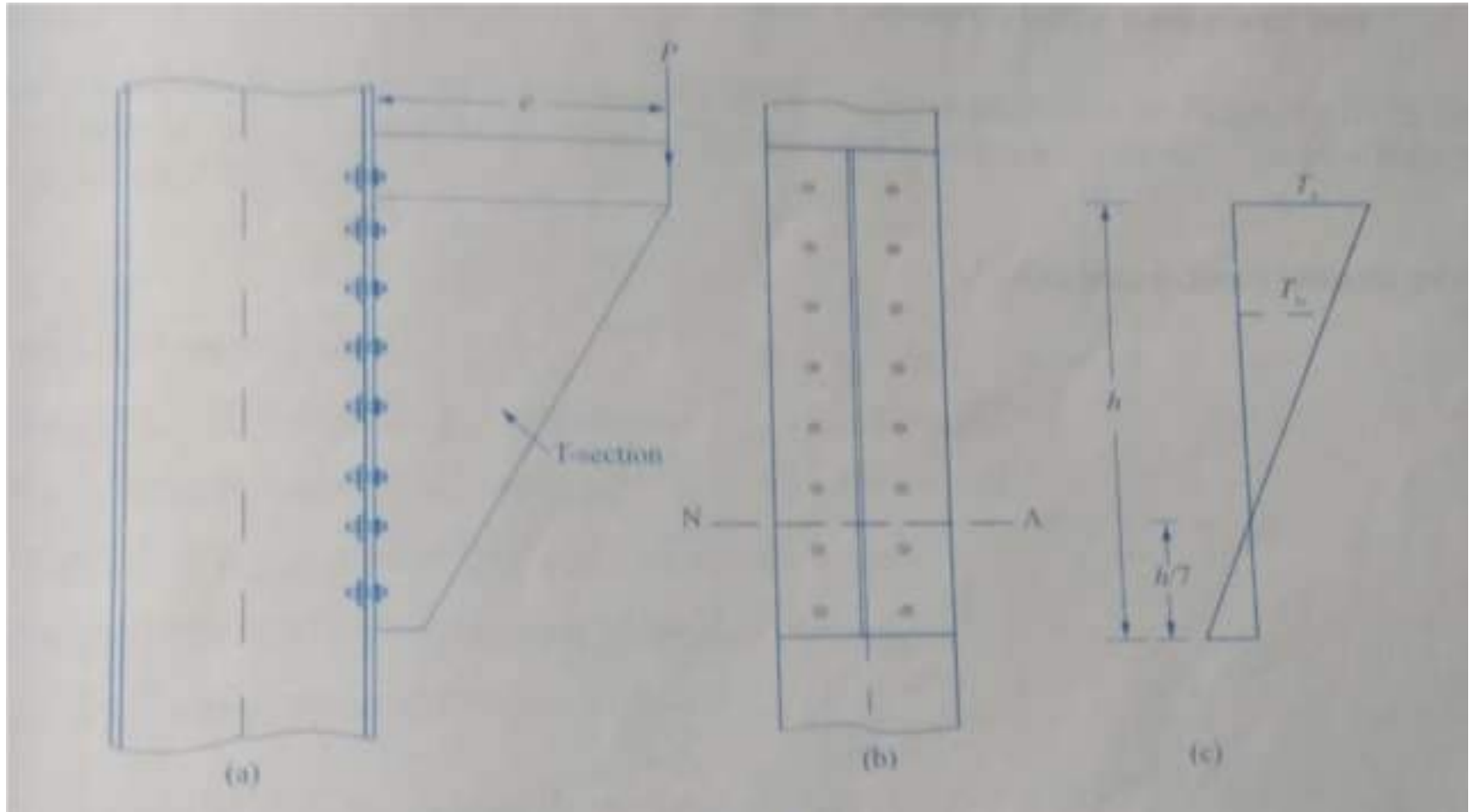

- Total tensile force $T = \sum T_{bi} = K \cdot y_i = (M' \sum y_i / \sum y_i^2)$
- Total tensile force = Total Compressive force
- $M = M' +$ Moment due to Compression
- $M = M' + (C = \sum T_{bi})(2/3) \cdot (h/7) =$
- $M' + (M' \sum y_i / \sum y_i^2) \cdot (2/3) \cdot (h/7)$
- $= M' \{1 + (2h/21) \cdot (\sum y_i / \sum y_i^2)\}$
- $M' = M / \{1 + (2h/21) \cdot (\sum y_i / \sum y_i^2)\}$
- Maximum tensile force in the extreme bolt $= T_b$ can be found.

$$\left(\frac{V_{sb}}{V_{db}}\right)^2 + \left(\frac{T_b}{T_{db}}\right)^2 \leq 1.0$$

Steps to be Followed

- Select nominal diameter d
- Take pitch $= 2.5d$ or $3d$
- Bolts are provided in two vertical rows. Number of bolts necessary

$$n = \sqrt{\frac{6M}{(2V)p}}$$

- $M =$ Moment in the joint, $V =$ Design strength of bolt

Design a suitable bracket connection of a ISHT-75 section attached to the flange of ISHB 300 @ 577 N/m to carry a vertical factor load 600 kN at an eccentricity of 60 mm. Use M24 bolt of grade 4.6

- **Solution:**

- For M24 bolt, $d=24$ mm, $d_0= 26$ mm, $f_{ub}=400$ Mpa
- For rolled steel $f_u=410$ Mpa
- Thickness of flange of ISHT 75= 9 mm
- Thickness of flange of ISHB 300= 10.6 mm
- Thickness of thinner member= 9 mm
- Design of bolts in single shear=

$$V_{dsb} = \frac{400}{1.25 * \sqrt{3}} \left(1 * 0.78 * \left(\frac{\pi}{4} \right) 24^2 + 0 * A_{sb} \right)$$
$$= 65.129 \text{ kN}$$

- Design of bolts in bearing $e=$ edge distance= $1.5*d_0=1.5*26=39$ mm
- Pitch $p=2.5*24=60$ mm
- Take $e= 40$ mm, $p=60$ mm

- $K_b=0.519$

$$k_b = \text{smaller of } \frac{40}{3 * 26}, \frac{60}{3 * 26} - 0.25, \frac{400}{410}, 1.0$$

$$= 0.519$$

- Design strength of bolt in bearing

$$\text{Bearing strength per bolt} = V_{dpb}$$

$$= 2.5 * 0.519 * 24 * 9 * \frac{410}{1.25} = 191.925 \text{ kN}$$

- So, design strength of bolt=65.129 kN
- Design tension capacity of bolts

$$T_{db} = \left(\frac{0.9 f_{ub} A_{nb}}{\gamma_m} \right) < \left(f_{yb} A_{sb} \frac{1}{\gamma_{mo}} \right)$$

$$T_{db} = \left(\frac{0.9 * 400 * 0.78 * \left(\frac{\pi}{4} \right) 24^2}{1.25} \right) = 101.624$$

$$< \left(240 * \left(\frac{\pi}{4} \right) 24^2 \frac{1}{1.1} \right) = 98.703$$

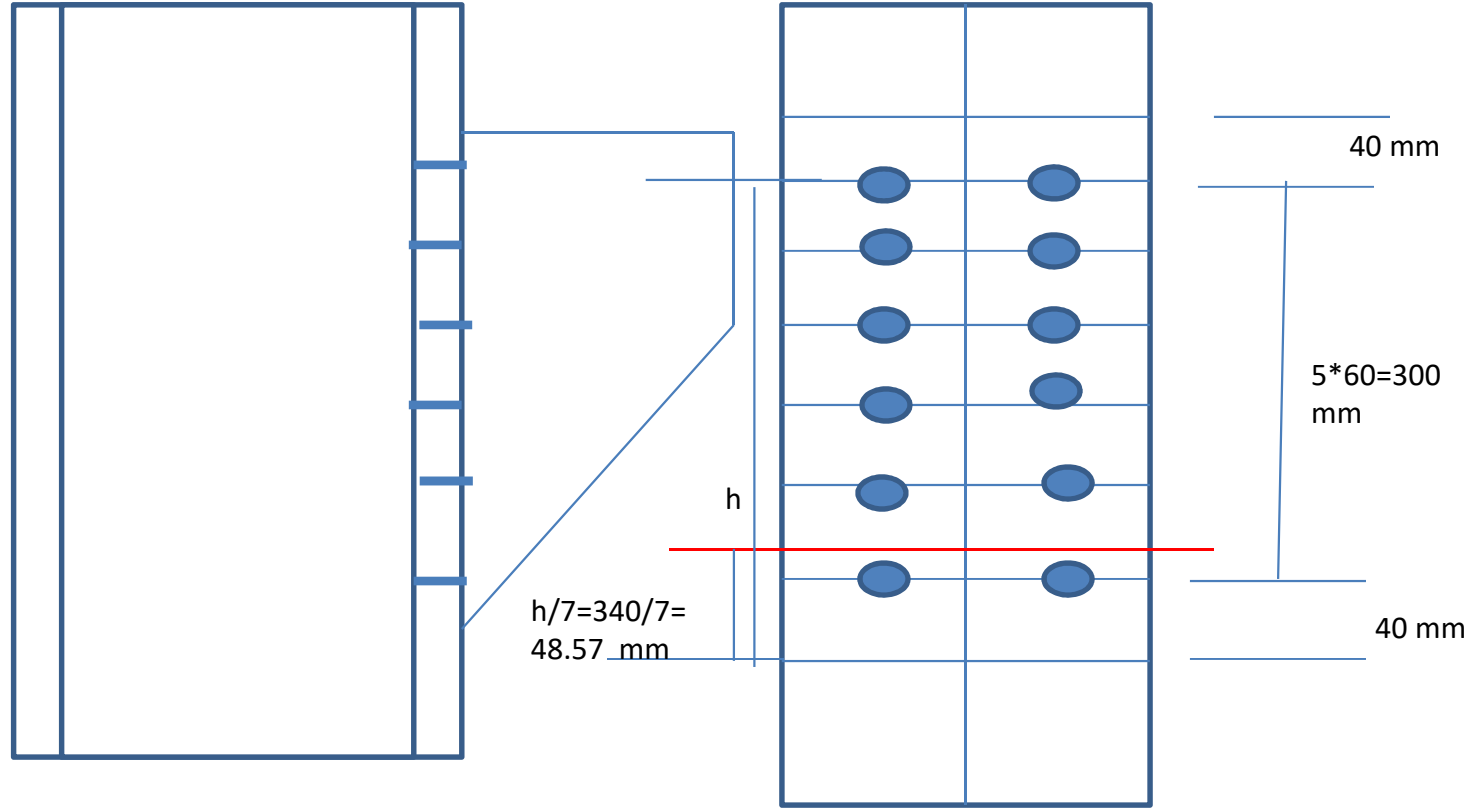

- $T_{db}=98.703\text{kN}$

$$n = \sqrt{\frac{6M}{(2V)p}} \quad n = \sqrt{\frac{6 * 600 * 1000 * 60}{(2 * 65192 * 60)p}} = 5.25 = \text{say } 6 \text{ no. } s$$

- $h=40+5*60=340 \text{ mm}$
- $h/7=48.57 \text{ mm}$
- Neutral axis lies in between 1st and 2nd bolt.
- $Y \text{ of } 2^{\text{nd}} \text{ bolt} = 40+60-48.57=51.43 \text{ mm}$

Bolt no	2	3	4	5	6	
y	51.43	111.43	171.43	231.43	291.43	Sum of $y=2*857.15$
y^2	2645.045	12416.64	29388.24	53559.84	84931.44	Sum of $y^2=2*182941.2$

- $M' = M / \{1 + (2h/21) * (\Sigma y_i / \Sigma y_i^2)\}$
- $M' = 600 * 1000 * 60 / \{1 + (2 * 340 / 21) * (2 * 857.15 / 2 * 182941.2)\} = 31.2577 \text{ kNM}$
- Tensile force in the extreme bolt due to moment = $T_b = K * y_i = (M' / \Sigma y_i^2) * y_i = 31.2577 * 10^6 * 291.43 / (2 * 18941.2) = 24.897 \text{ kN}$
- Direct shear = Total load / no. of bolts = $600 / 12 = 50 \text{ kN}$

$$\left(\frac{V_{sb}}{V_{db}}\right)^2 + \left(\frac{T_b}{T_{db}}\right)^2 \leq 1.0$$

- $(50/65.192)^2 + (24.897/98.703)^2 = 0.652 < 1.0$ So OK.

HSFG BOLTS

- design principle of high strength friction grip bolt.
- Now in case of high strength friction grip bolt, the friction will be coming into picture for calculating the design strength of the bolt.
- High strength friction grip bolt is used when the external force is quite high. To accommodate the bolt in a shorter length of the joint, we may have to reduce the number of bolt. So in that case, generally we go for high strength friction grip bolt with laser number of friction grip bolt.
- These bolts are made from high tensile steel which are pretensioned.
- HSFG bolts are designed for no slip at serviceability , they may slip at higher loads and slip into bearing at ultimate.
- Such bolts to be checked at ultimate.
- Waisted Shank HSFG bolts are designed for no slip even at ultimate.

Parallel shank

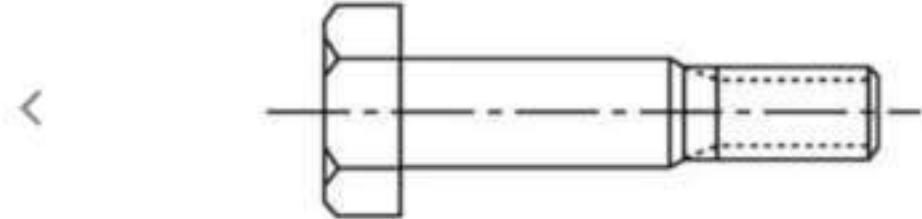
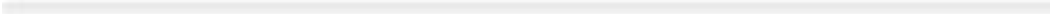

Waist Shank Type



In cases where bolts failed due to cyclic bending, such as eccentric loading, replacing the original bolt with a waisted shank bolt could improve the joint performance. Due to its smaller diameter, the waisted shank would result in lower fatigue stress under the same bending condition, thus increasing the life of the joint.

- $V_{nsf} = \mu_f n_e k_h F_0$
- Where V_{nsf} = nominal shear capacity of bolt
- μ_f = coefficient of friction (Ref. Clause 10.4.3, Table 20)
- n_e = number of effective interfaces offering frictional resistance to slip (1 for lap joint, 2 for double cover butt joint)
- $K_h = 1.0$ for fasteners in clearance holes
 = 0.85 for fasteners in oversized and short slotted holes and long slotted holes loaded perpendicular to the slots
 = 0.7 for fasteners in long slotted holes loaded parallel to the slots
- F_0 = proof load = $A_{nb} * f_0$,
- f_0 = proof stress = $0.7 f_{ub}$
- A_{nb} = net area of bolts at threads = 0.78 times shank area
- f_{ub} = Ultimate tensile stress in bolt
- Design shear strength of HSFG bolts
- $V_{dsf} = \frac{V_{nsf}}{\gamma_{mf}}$
- $\gamma_{mf} = 1.10$ if the slip resistance is designed at service load (Parallel shank HSFG)
- $\gamma_{mf} = 1.25$ if the slip resistance is designed at ultimate load (Waisted shank HSFG)

ADVANTAGES IF HSFG OVER BEARING TYPE

- 1. Joints are rigid.
- 2. As load transfer is through friction , bolts are not subjected to shearing or bearing.
- 3. High static strength due to high frictional resistance.

BOLTS IN TENSION

- Strength of Bolts in tension
- Nominal : $T_{nf} = (0.9 * f_u * A_n) \leq (f_{yb} A_{sb} \gamma_{mb} / \gamma_{m1})$
- Design : $T_{df} = (0.9 * f_u * A_n / \gamma_{mb}) \leq (f_{yb} * A_{sb} / \gamma_{m1})$

So what we can see here that it has an applied force and in the opposite direction of applied force bolt force is coming. So if the applied force is $2T_e$ then bolt force is T_e , this equation is true if deformation of the flange is not allowed. If deformation is allowed, then what will happen that some additional forces at the connection will be developed. This additional force is called prying force that means due to application of load of $2T_e$, the bolt is getting force as T_e but if we allow the deformation of the flange then additional prying force will come into picture. So if Q is the prying force then bolt force will be $(T_e + Q)$. So the prying force will be developed at the connection and to withstand that force bolt will face extra force of amount Q and this Q value has been calculated and reported in clause 10.4.7.

PRYING FORCE

HSFG bolt apart from shearing, bearing and tension, prying force may also come into picture. So the bolt we supposed to take will have some additional value of Q that means if T_e is the external force on bolt then actual force will be $T_e + Q$ where Q is a prying force.

$$Q = \left[\frac{l_v}{2l_e} \right] \left[T_e - \frac{\beta \eta f_0 b_e t^4}{27 l_2 l_v^2} \right]$$

Q = additional force of fastener due to prying action

l_v = distance from bolt centre line to toe of fillet weld or to half the root radius of a rolled section

(figure. 16 of IS 800)

l_e = distance between prying force and bolt centre line

(figure. 16 of IS 800)

$$l_e = 1.1 * t \sqrt{b f_0 / f_y}$$

$\beta = 2$ for non-pre-tensioned bolts = 1 for pre-tensioned bolts

$\eta = 1.5$

f_0 = proof stress

t = thickness of end plate

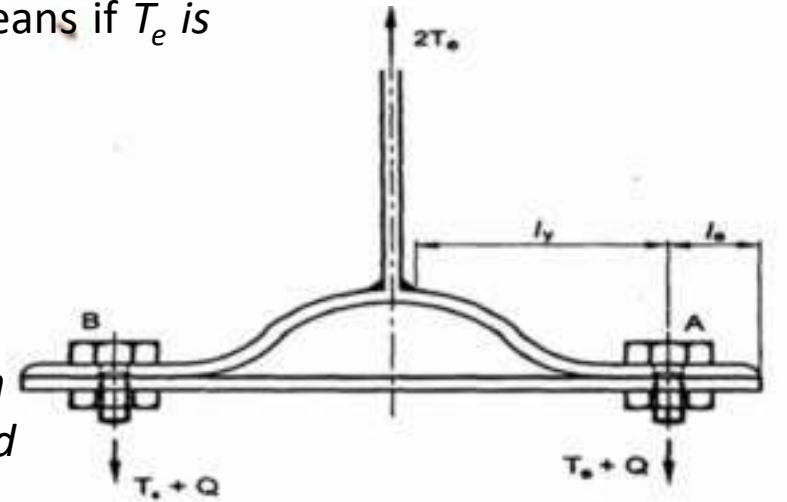

$$t_{min} = \sqrt{4.4M_p f_0 / (f_y b_e)}$$

$$M_p = \frac{T_e l_v}{2} = Ql_2$$

An ISA 110 mm × 110 mm × 10 mm carries a factored tensile force of 150 kN. It is to be jointed with a 10 mm thick gusset plate. Design the joint using HSFG bolt when (a) no slip is permitted, (b) when slip is permitted. Assume steel is Fe 410 grade.

Let us provide HSFG bolts of grade 8.8 and of diameter 20 mm.

For 8.8 grade bolts: $f_{ub} = 800 \text{ MPa}$

Net tensile stress area of bolt = $A_{nb} = 0.78 * (\pi / 4) * 20^2 = 245 \text{ mm}^2$

For Fe 410 grade of steel: $f_u = 410 \text{ MPa}$

a) Slip-critical connection (slip is not permitted):

For proof load, $F_0 = A_{nb} * 0.7 f_{ub} = 245 * 0.7 * 800 = 137.2 \text{ kN}$

Slip resistance of bolt = $\mu_f \eta_e k_h F_0 / \gamma_{mf} =$

$\mu_f = 0.5$ (assuming)

$\eta_e =$ no. of effective interface offering frictional resistance to slip = 1,

$\gamma_{mf} = 1.25$ at ultimate load

$k_h = 1$ Assuming bolts in clearance hole

Slip resistance of bolt = $0.5 * 1 * 1 * 137.2 / 1.25 = 54.88 \text{ kN}$